

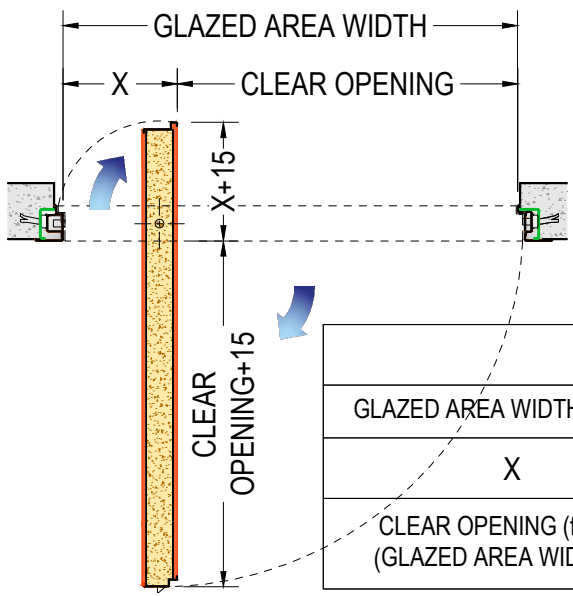

**FRAMES and SUBFRAMES
SECURITY DOORS DI.BIG**

TECHNICAL DRAWINGS
rev. 2018.08.02.

EXTERNAL SIDE

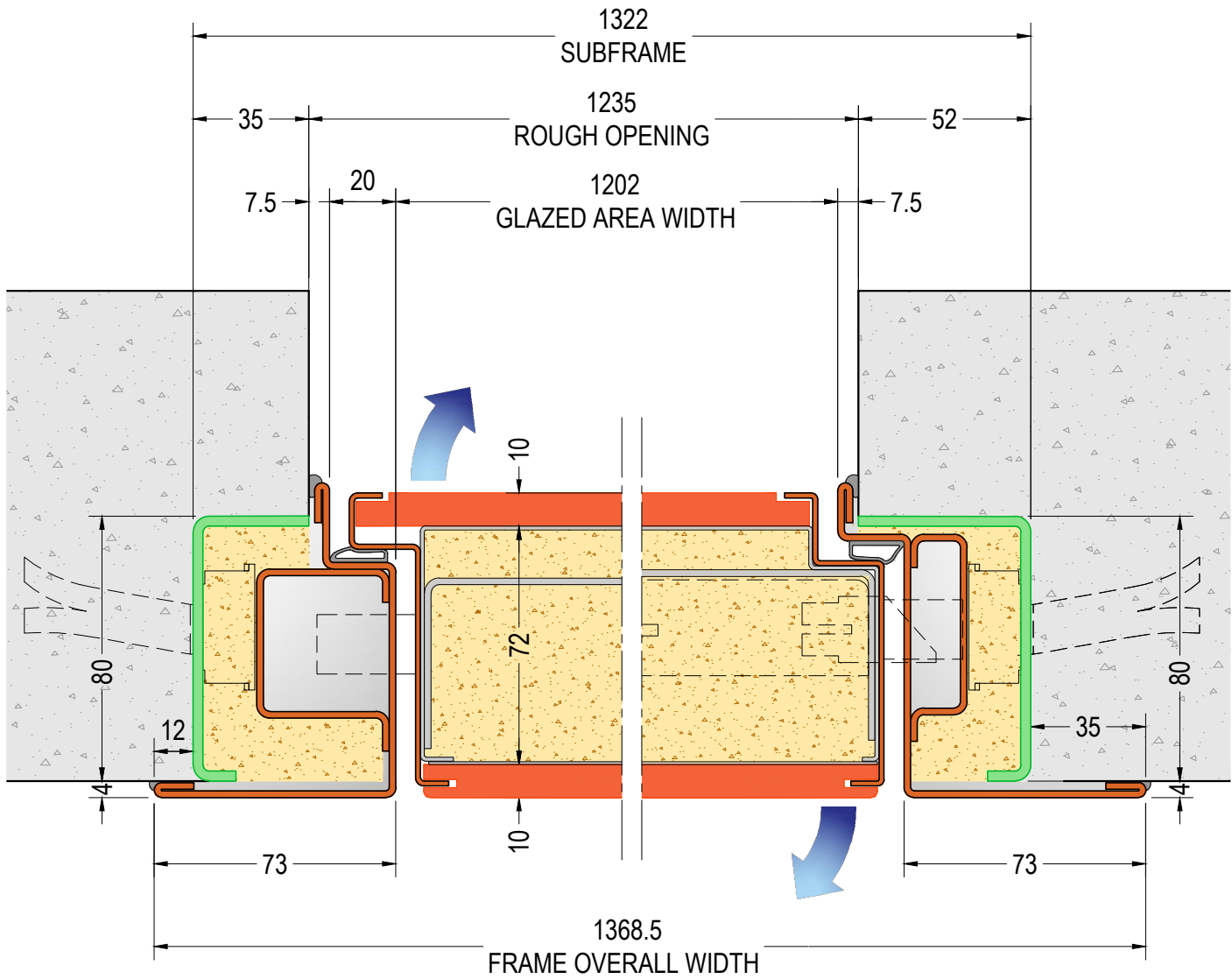

**DOOR HORIZONTAL SECTION
MODEL "A"**
ref. DOOR W=1200(900+300)

CLEAR OPENING CALCULATION				
GLAZED AREA WIDTH (from-to)	1100-1300	1301-1400	1401-1550	1551-1700
X	300	350	400	450
CLEAR OPENING (from-to) (GLAZED AREA WIDTH - X)	800-1000	951-1050	1001-1150	1001-1250



SUBFRAME AND FRAME FOR DI.BIG PIVOT SECURITY DOOR - Solution 20

26.1

HORIZONTAL SECTION - scale 1:2

v 1.5

DI.BI. PORTE BLINDATE Srl - Fano (PU) ITALY - www.dibigroup.com

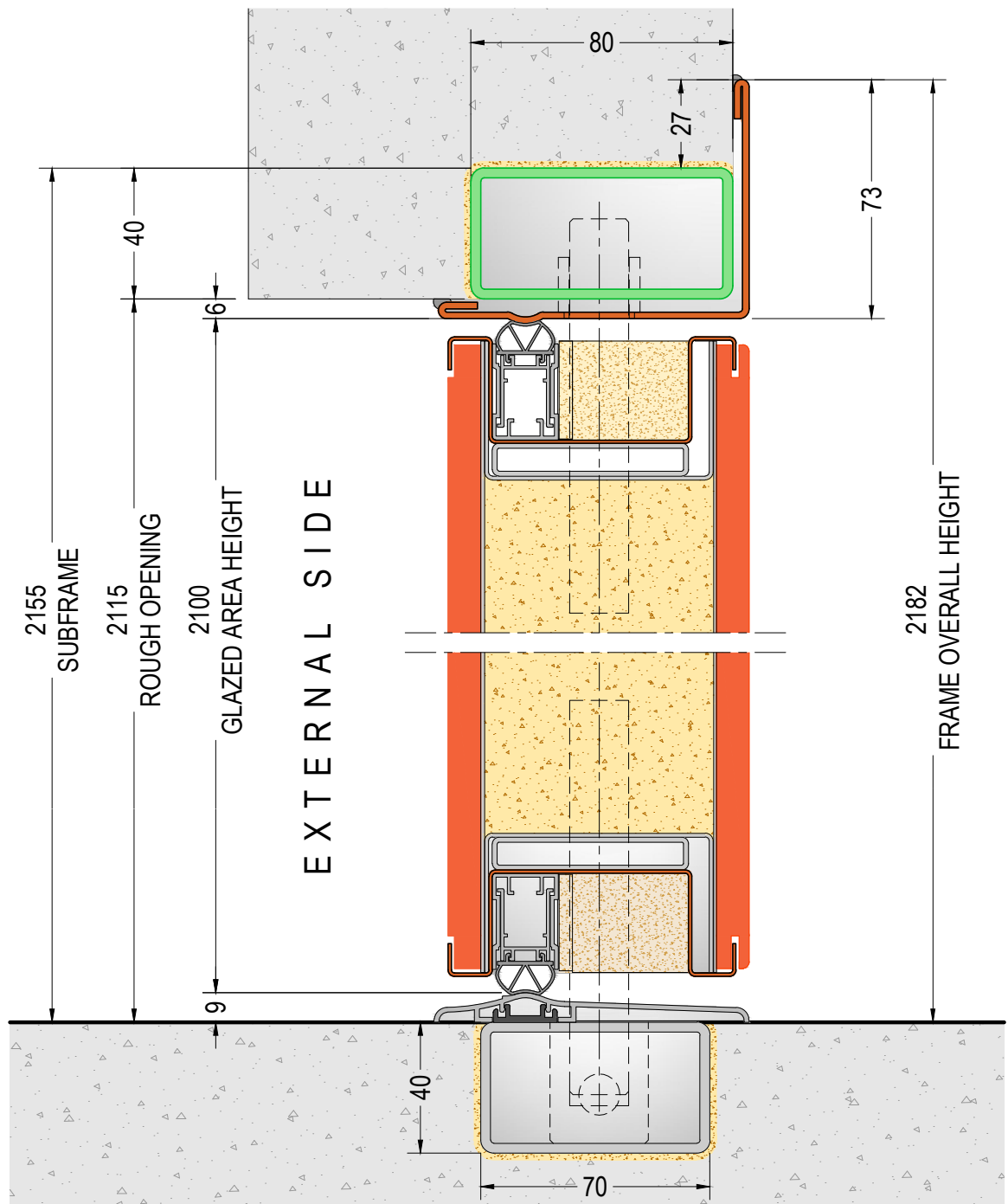

**DOOR VERTICAL SECTION
MODEL "A"**
ref. DOOR H=2100

DOOR DIMENSIONS:
W=min.1100 - max.1700
H=min.2100 - max.2700



external side view



**SUBFRAME AND FRAME FOR
DI.BIG PIVOT SECURITY
DOOR - Solution 20**

26.2

VERTICAL SECTION - scale 1:2

v 1.5

DI.BI. PORTE BLINDATE Srl - Fano (PU) ITALY - www.dibigroup.com

EXTERNAL SIDE

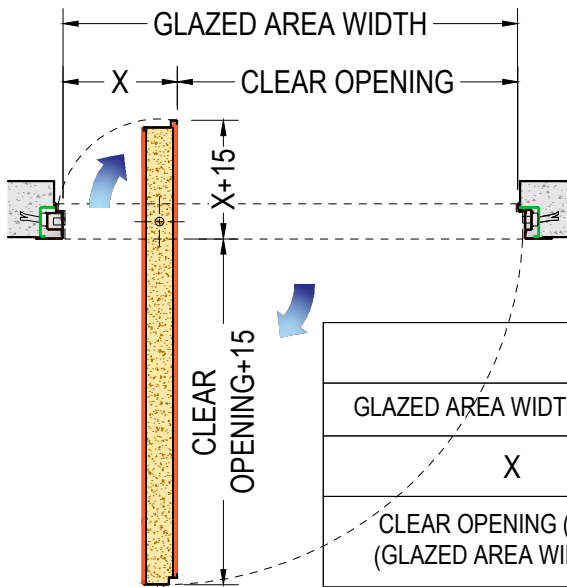
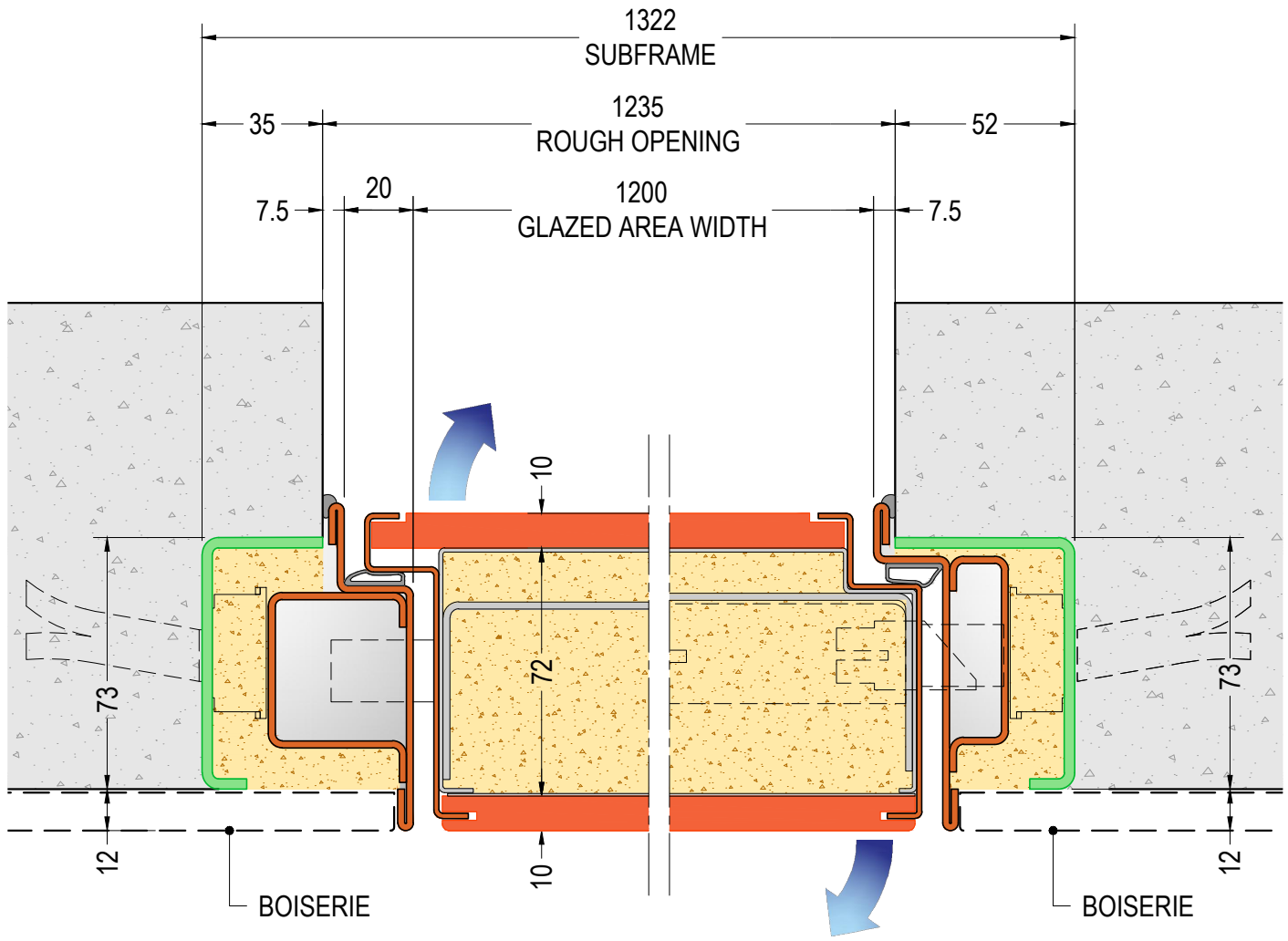

**DOOR HORIZONTAL SECTION
MODEL "A"**
ref. DOOR W=1200(900+300)

CLEAR OPENING CALCULATION				
GLAZED AREA WIDTH (from-to)	1100-1300	1301-1400	1401-1550	1551-1700
X	300	350	400	450
CLEAR OPENING (from-to) (GLAZED AREA WIDTH - X)	800-1000	951-1050	1001-1150	1001-1250



**SUBFRAME AND FRAME FOR
DI.BIG PIVOT DOOR with
interior wall finish - Solution 21**

26.3

HORIZONTAL SECTION - scale 1:2

v 1.5

DI.BI. PORTE BLINDATE Srl - Fano (PU) ITALY - www.dibigroup.com

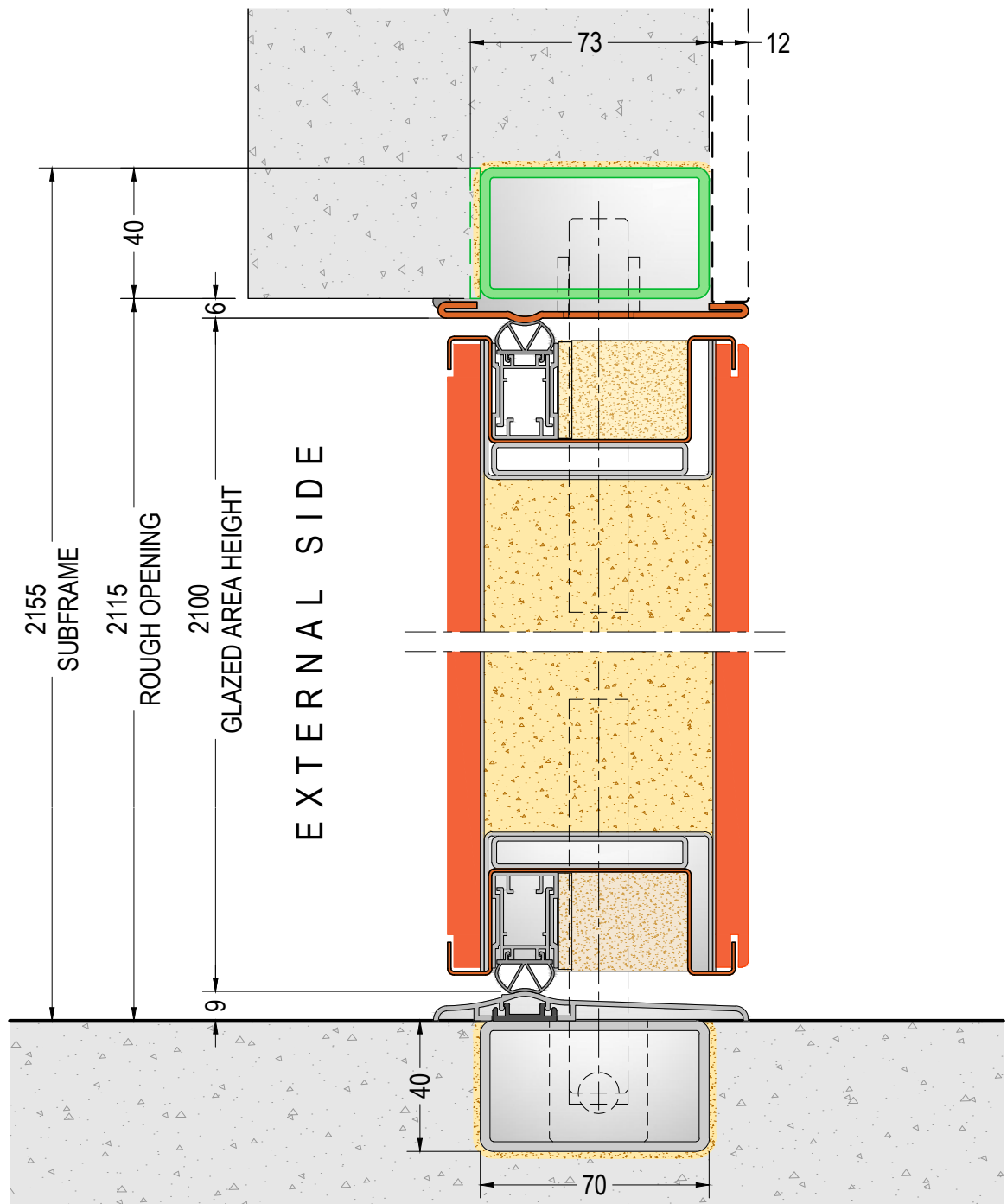

**DOOR VERTICAL SECTION
MODEL "A"**
ref. DOOR H=2100

DOOR DIMENSIONS:
W=min.1100 - max.1700
H=min.2100 - max.2700



external side view



SUBFRAME AND FRAME FOR DI.BIG PIVOT DOOR with
26.4
interior wall finish - Solution 21

HORIZONTAL SECTION - scale 1:2

v 1.5

DI.BI. PORTE BLINDATE Srl - Fano (PU) ITALY - www.dibigroup.com

EXTERNAL SIDE

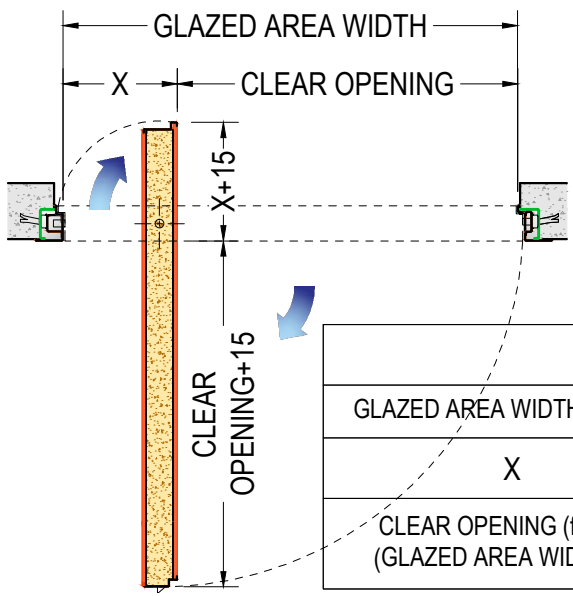
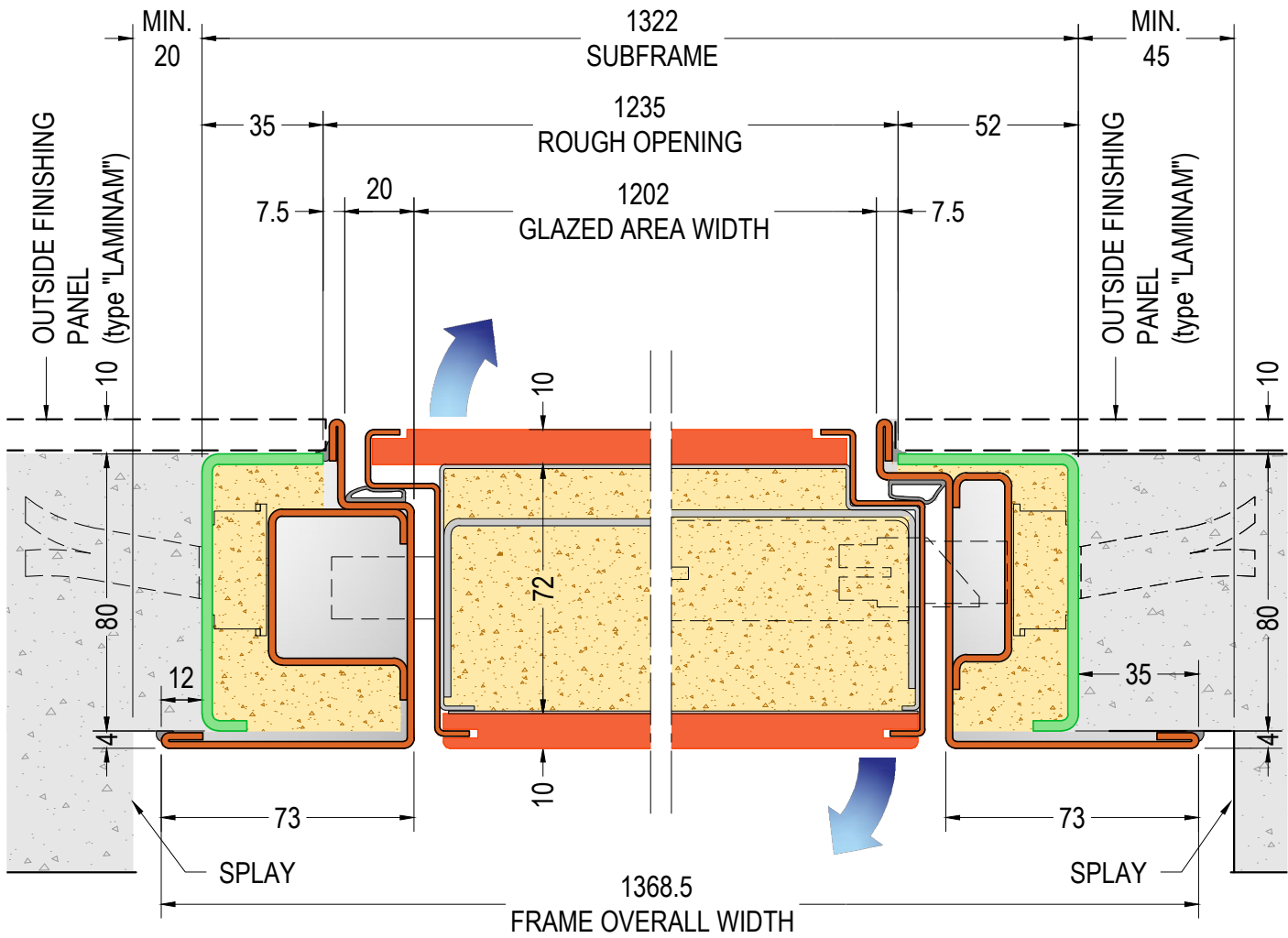

DOOR HORIZONTAL SECTION MODEL "A"
ref. DOOR W=1200(900+300)

CLEAR OPENING CALCULATION				
GLAZED AREA WIDTH (from-to)	1100-1300	1301-1400	1401-1550	1551-1700
X	300	350	400	450
CLEAR OPENING (from-to) (GLAZED AREA WIDTH - X)	800-1000	951-1050	1001-1150	1001-1250



SUBFRAME AND FRAME FOR DI.BIG PIVOT DOOR with 26.5 exterior wall finish - Solution 22

HORIZONTAL SECTION - scale 1:2 v 1.5

DI.BI. PORTE BLINDATE Srl - Fano (PU) ITALY - www.dibigroup.com

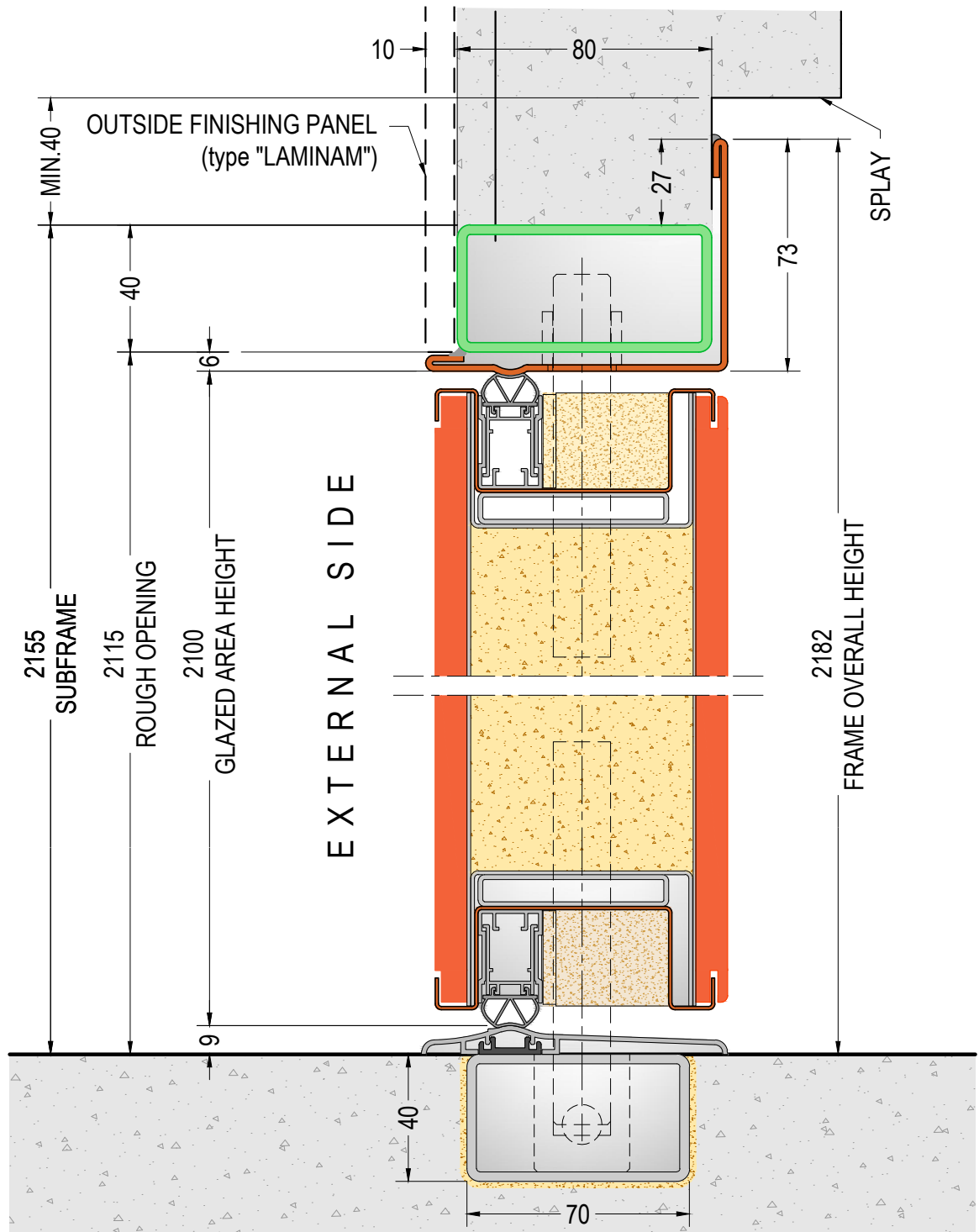

**DOOR VERTICAL SECTION
MODEL "A"**
ref. DOOR H=2100

DOOR DIMENSIONS:
W=min.1100 - max.1700
H=min.2100 - max.2700



external side view



SUBFRAME AND FRAME FOR **26.6**
DI.BIG PIVOT DOOR with
exterior wall finish - Solution 22

HORIZONTAL SECTION - scale 1:2

v 1.5

DI.BI. PORTE BLINDATE Srl - Fano (PU) ITALY - www.dibigroup.com

EXTERNAL SIDE

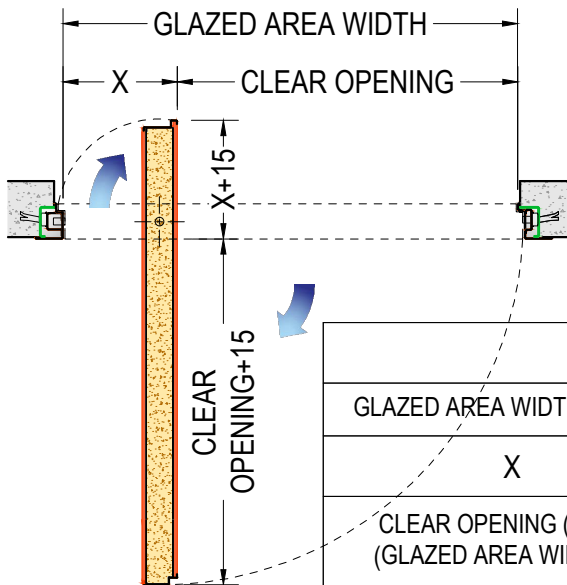
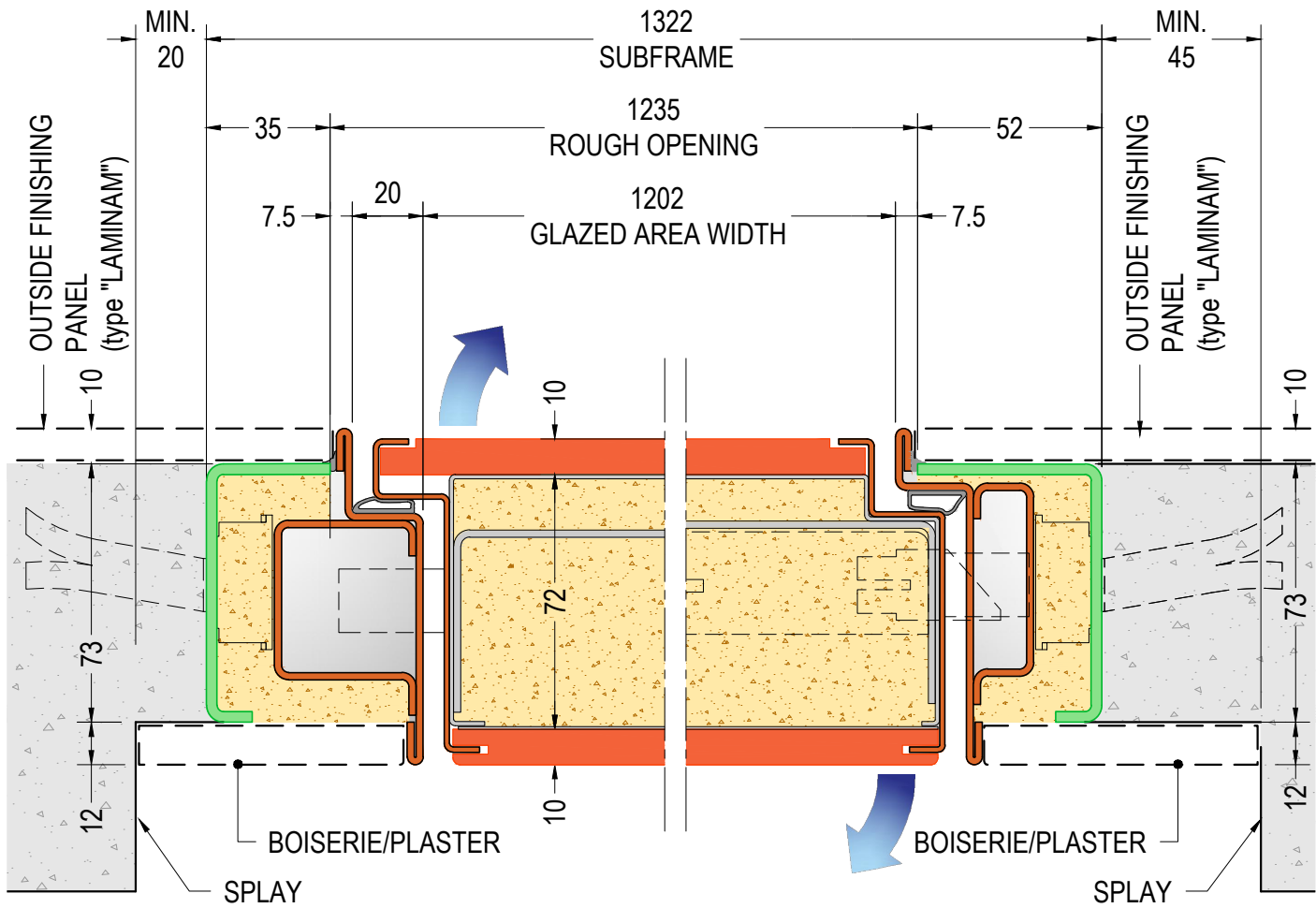

**DOOR HORIZONTAL SECTION
MODEL "A"**
ref. DOOR W=1200(900+300)

CLEAR OPENING CALCULATION				
GLAZED AREA WIDTH (from-to)	1100-1300	1301-1400	1401-1550	1551-1700
X	300	350	400	450
CLEAR OPENING (from-to) (GLAZED AREA WIDTH - X)	800-1000	951-1050	1001-1150	1001-1250



**SUBFRAME AND FRAME FOR DI.BIG
PIVOT DOOR with exterior and
interior wall finish - Solution 23**

26.7

HORIZONTAL SECTION - scale 1:2

v 1.5

DI.BI. PORTE BLINDATE Srl - Fano (PU) ITALY - www.dibigroup.com

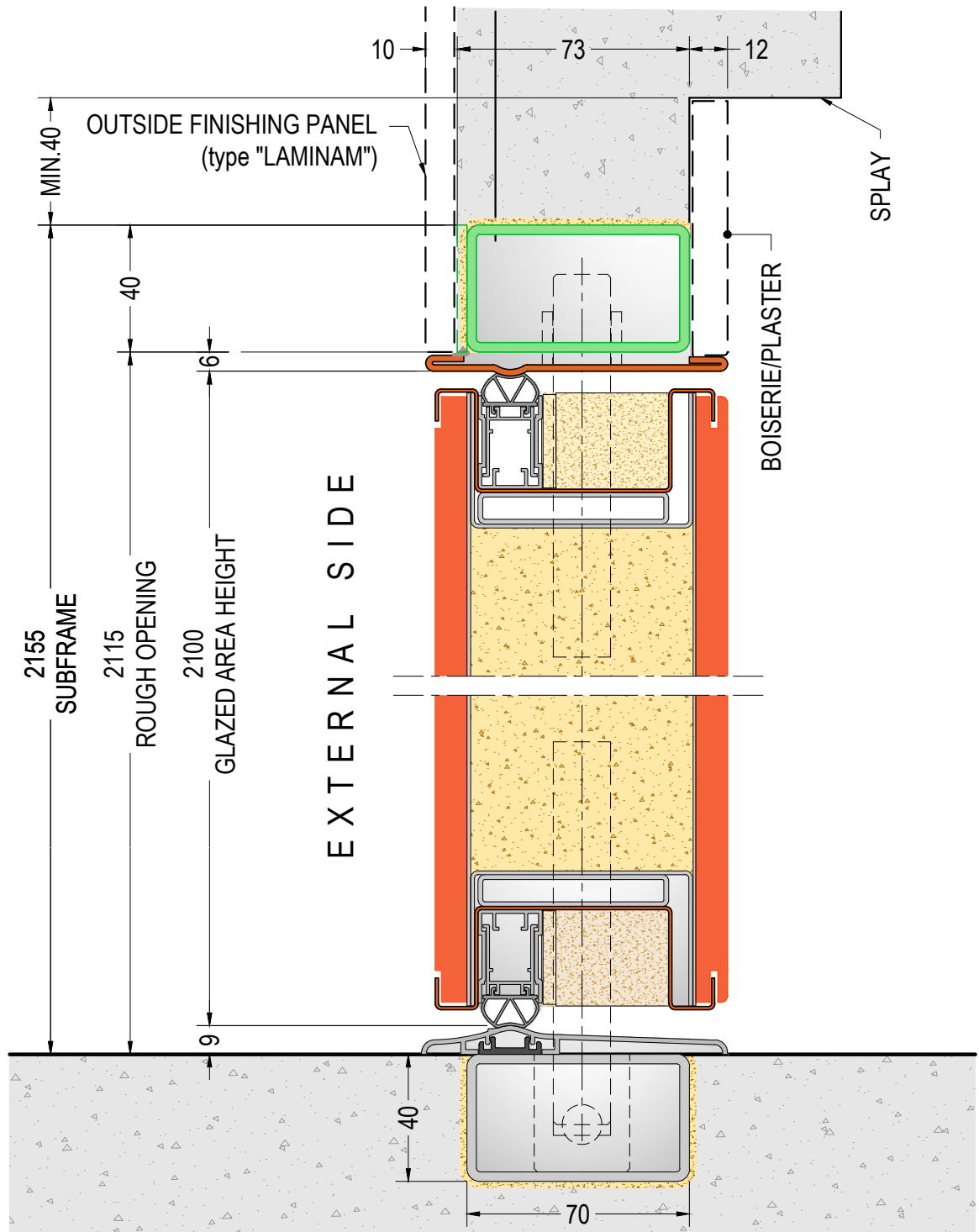

**DOOR VERTICAL SECTION
MODEL "A"**
ref. DOOR H=2100

DOOR DIMENSIONS:
W=min.1100 - max.1700
H=min.2100 - max.2700



external side view



**SUBFRAME AND FRAME FOR DI.BIG
PIVOT DOOR with exterior and
interior wall finish - Solution 23**

26.8

HORIZONTAL SECTION - scale 1:2

v 1.5

DI.BI. PORTE BLINDATE Srl - Fano (PU) ITALY - www.dibigroup.com

EXTERNAL SIDE

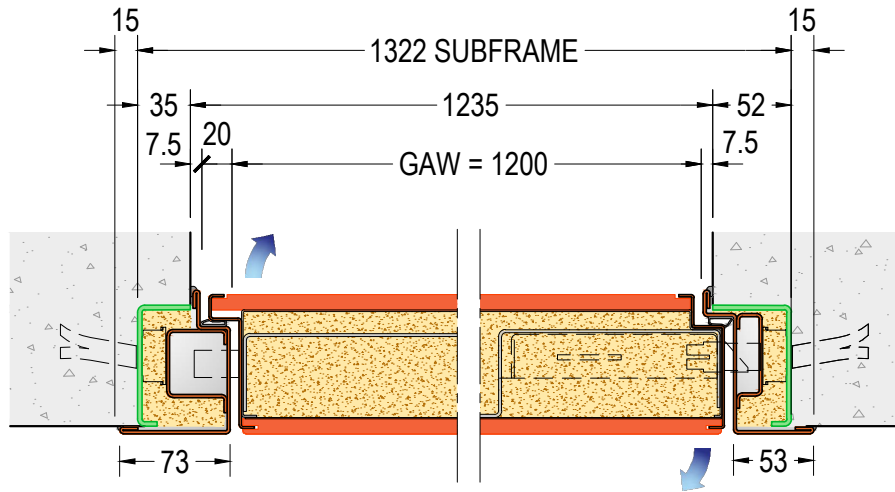

DOOR HORIZONTAL SECTION - MODEL "B"

ref. DOOR W=1200 - GLAZED AREA WIDTH GAW=1200

EXTERNAL SIDE

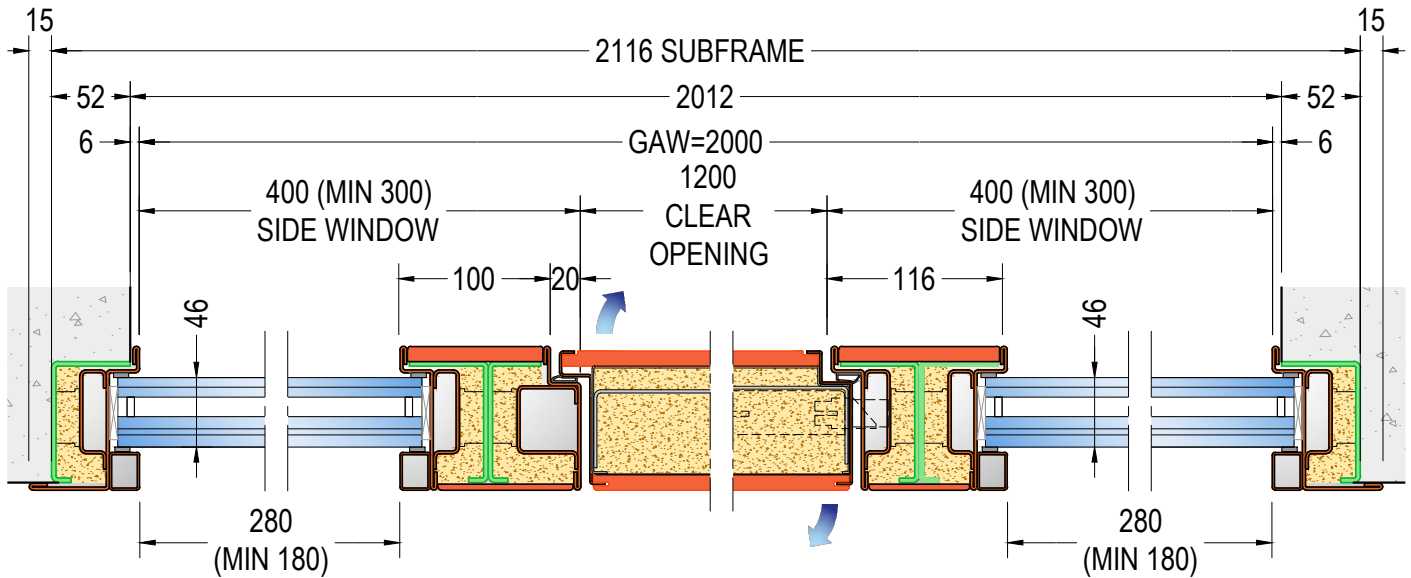

DOOR HORIZONTAL SECTION - MODELS "E-F"

ref. DOOR W=1200 - SIDE WINDOW 400
GLAZED AREA WIDTH GAW=2000

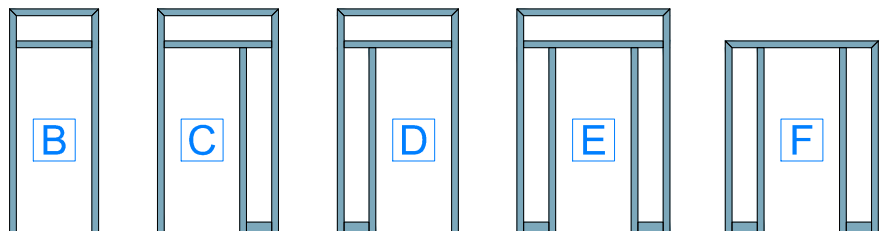

external side view



SUBFRAME AND FRAME FOR DI.BIG PIVOT SECURITY DOOR 27.1 WITH SIDE AND TOP WINDOWS

HORIZONTAL SECTIONS - scale 1:5

v1.7

DI.BI. PORTE BLINDATE Srl - Fano (PU) ITALY - www.dibigroup.com

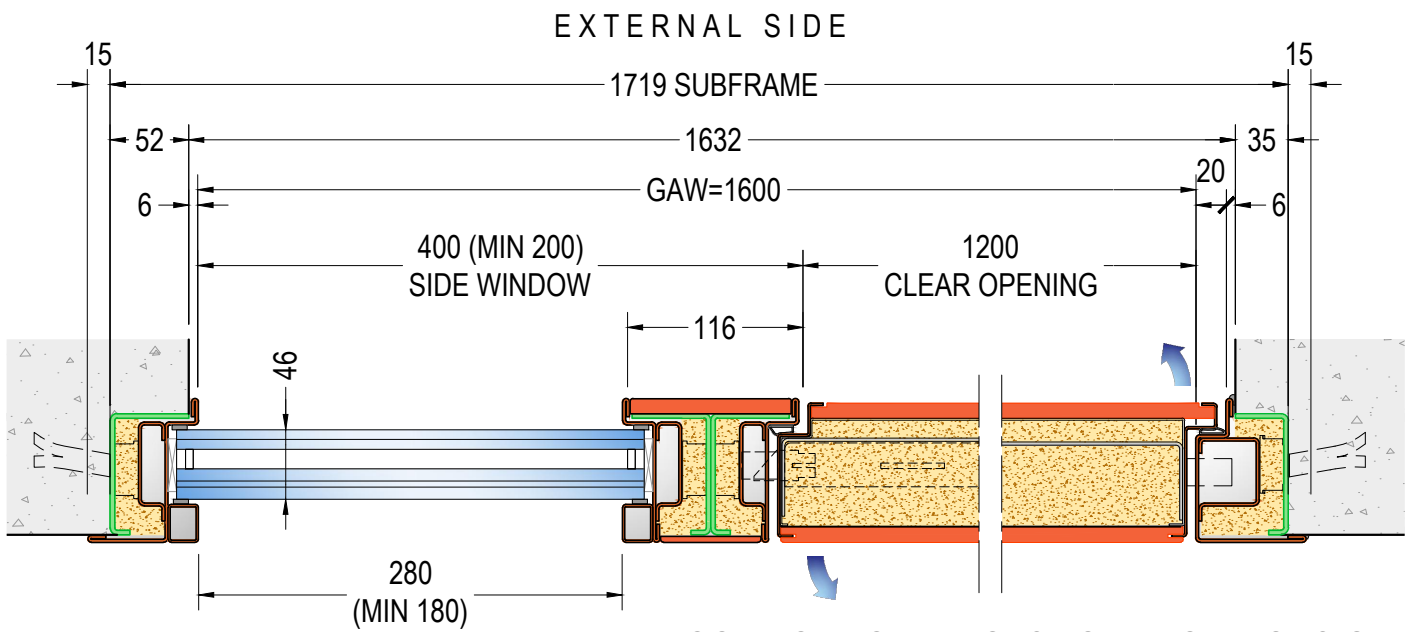

DOOR HORIZONTAL SECTION - MODELS "C-G"

ref. DOOR W=1200 - SIDE WINDOW 400
GLAZED AREA WIDTH GAW=1600

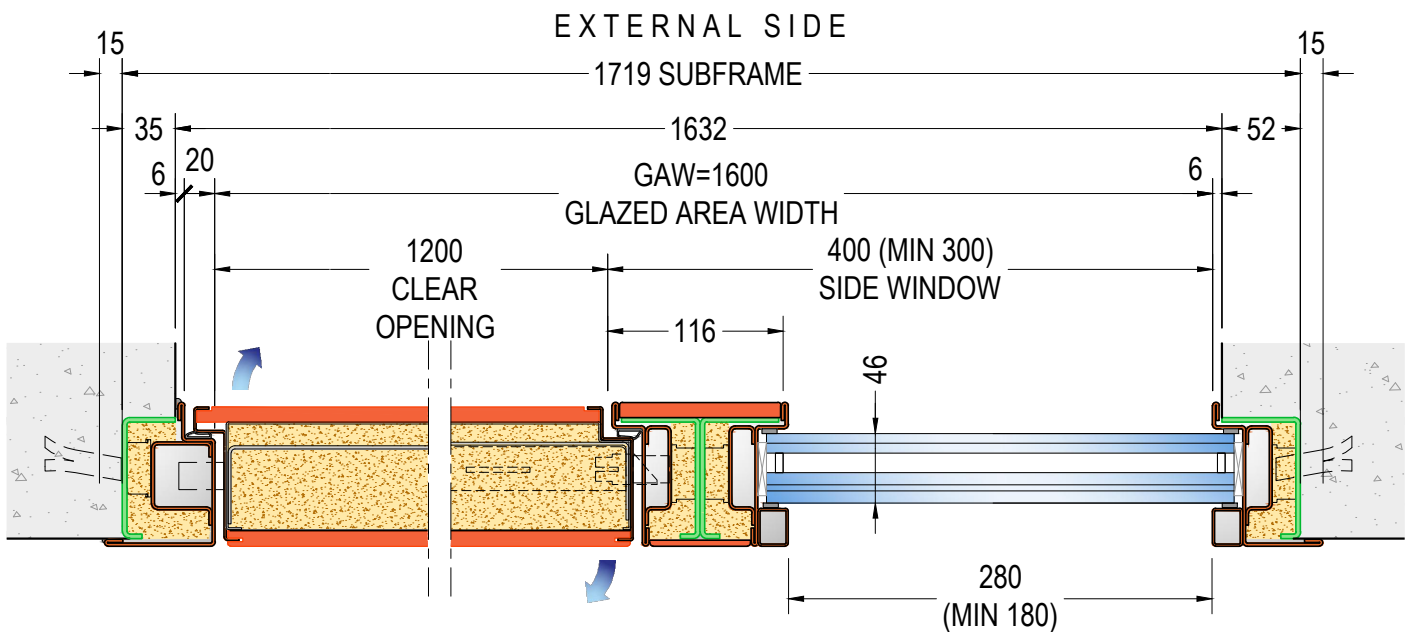

DOOR HORIZONTAL SECTION - MODELS "D-H"

ref. DOOR W=1200 - SIDE WINDOW 400
GLAZED AREA WIDTH GAW=1600

GLAZED AREA:
MAXIMUM OVERALL DIMENSIONS
(GAWxGAH / GAHxGAW)
2900x3700 (CDE) 3700x2700 (FGH)

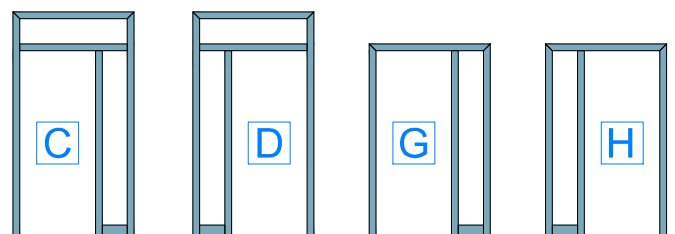

external side view



SUBFRAME AND FRAME FOR DI.BIG PIVOT SECURITY DOOR 27.2 WITH SIDE AND TOP WINDOWS

HORIZONTAL SECTIONS - scale 1:5

v1.7

DI.BI. PORTE BLINDATE Srl - Fano (PU) ITALY - www.dibigroup.com

EXTERNAL SIDE

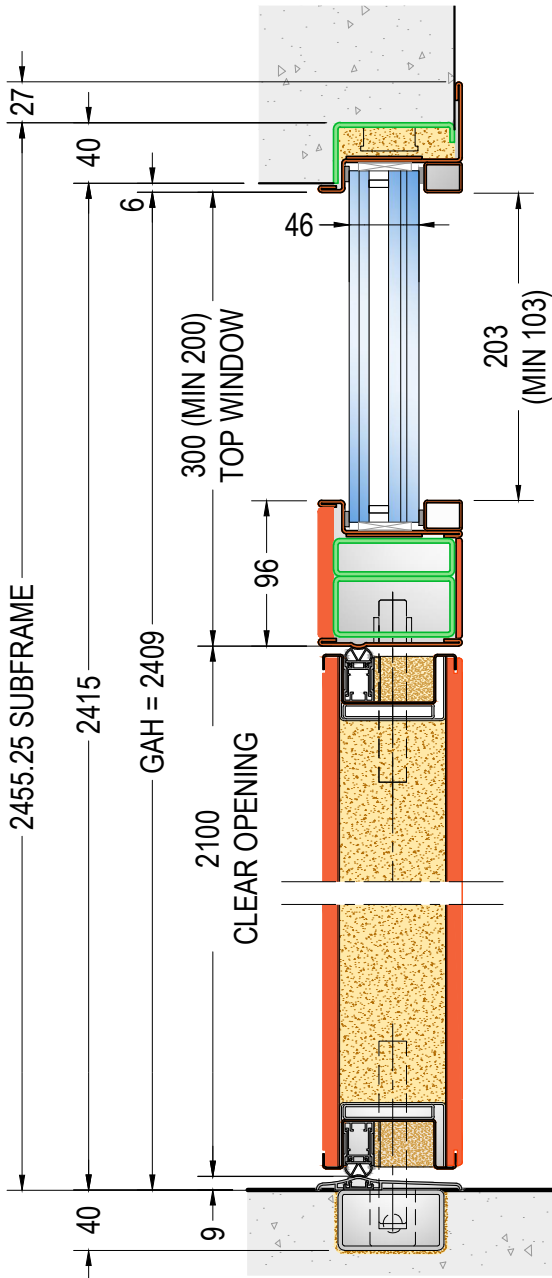

**DOOR VERTICAL SECTION
MODELS "B-C-D-E"**

ref. DOOR H=2100 - TOP WINDOW 300
GLAZED AREA HEIGHT GAH=2409

EXTERNAL SIDE

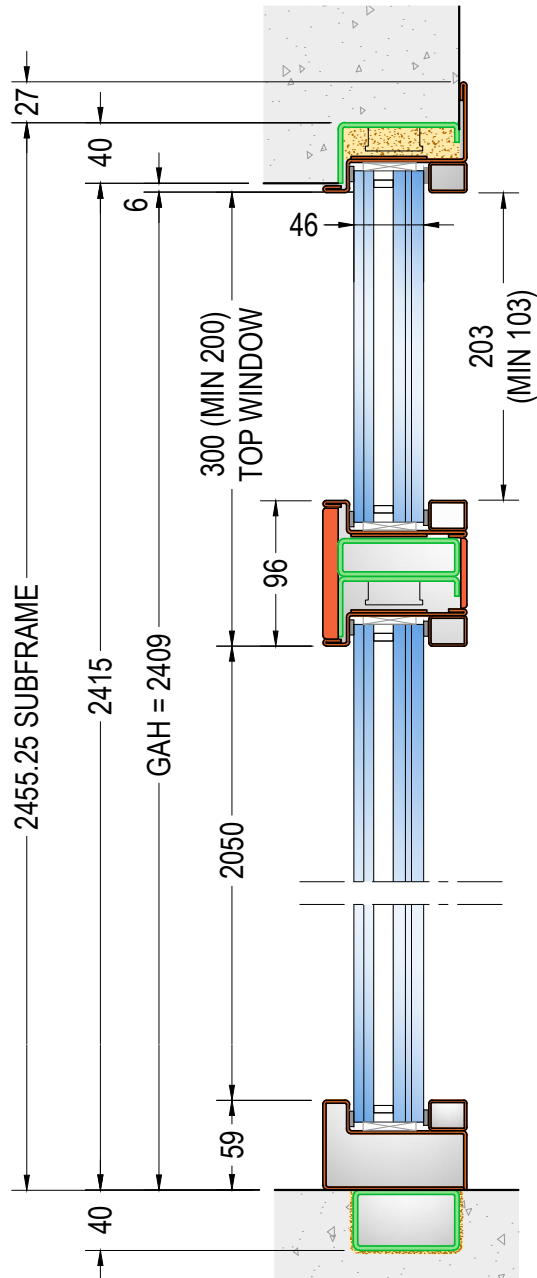

**SIDE WINDOW VERTICAL SECTION
MODELS "C-D-E"**

ref. DOOR H=2100 - TOP WINDOW 300
GLAZED AREA HEIGHT GAH=2409

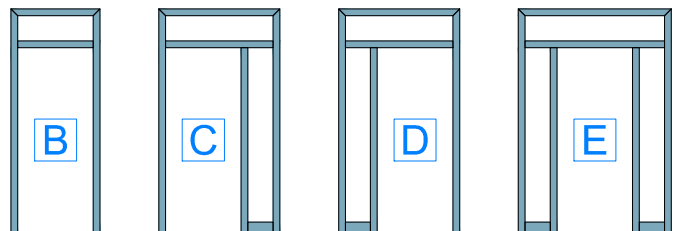

external side view



**SUBFRAME AND FRAME FOR DI.BIG PIVOT SECURITY DOOR 27.3
WITH SIDE AND TOP WINDOWS**

VERTICAL SECTIONS - scale 1:2

v1.7

DI.BI. PORTE BLINDATE Srl - Fano (PU) ITALY - www.dibigroup.com

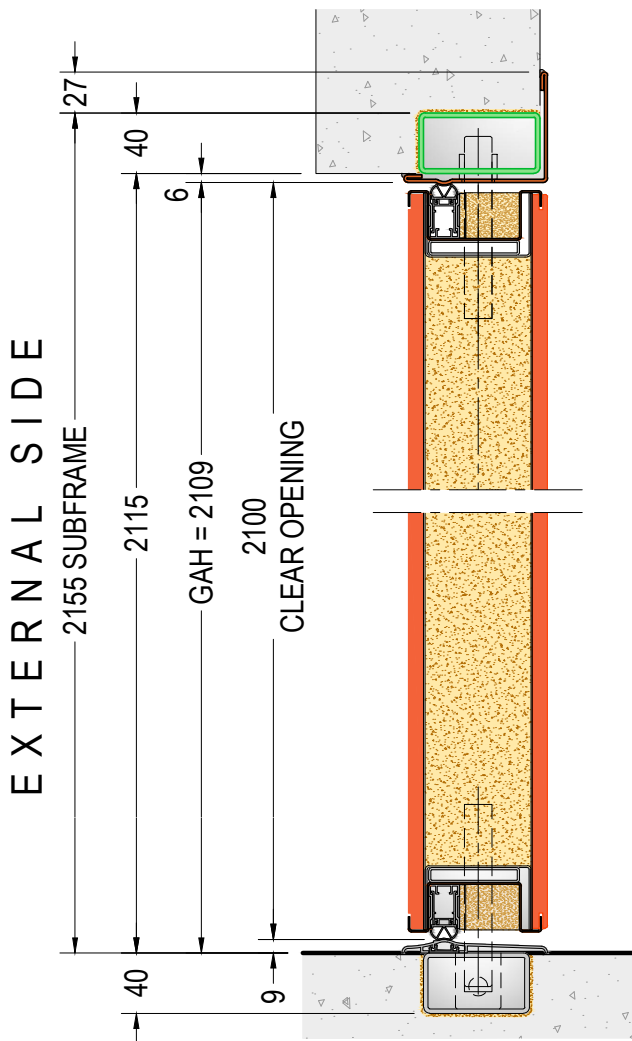

DOOR VERTICAL SECTION
MODELS "F-G-H"
 ref. DOOR H=2100
 GLAZED AREA HEIGHT GAH=2109

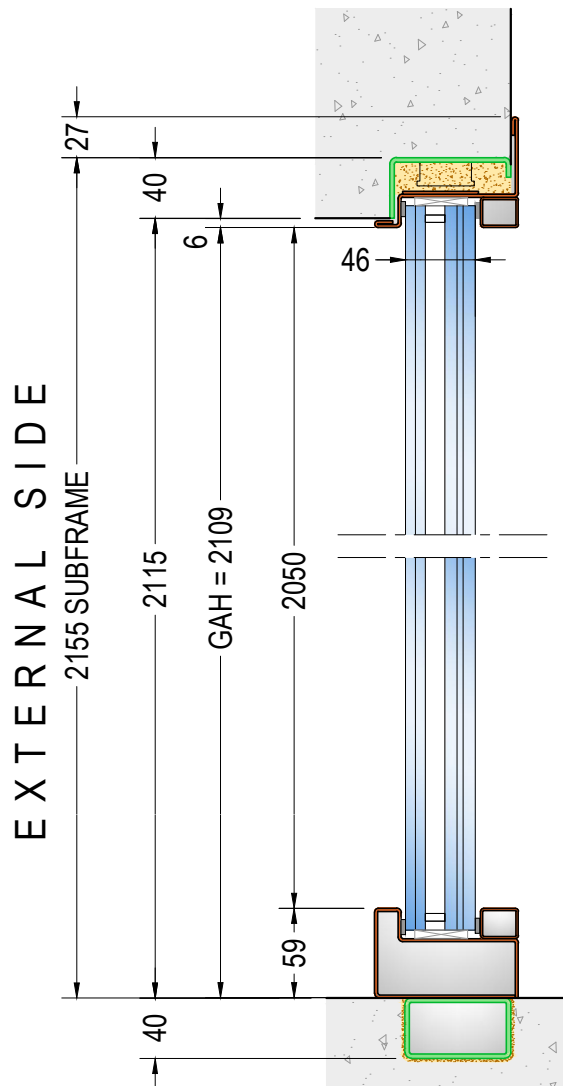

SIDE WINDOW VERTICAL SECTION
MODELS "F-G-H"
 ref. DOOR H=2100
 GLAZED AREA HEIGHT GAH=2109

GLAZED AREA:
 MAXIMUM OVERALL DIMENSIONS
 (GAWxGAH / GAHxGAW)
2900x3700 (CDE) 3700x2700 (FGH)

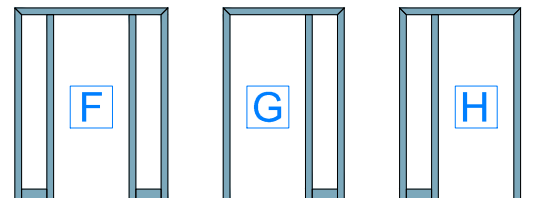

external side view



SUBFRAME AND FRAME FOR DI.BIG PIVOT SECURITY DOOR 27.4
WITH SIDE AND TOP WINDOWS

VERTICAL SECTIONS - scale 1:2

v1.7

DI.BI. PORTE BLINDATE Srl - Fano (PU) ITALY - www.dibigroup.com

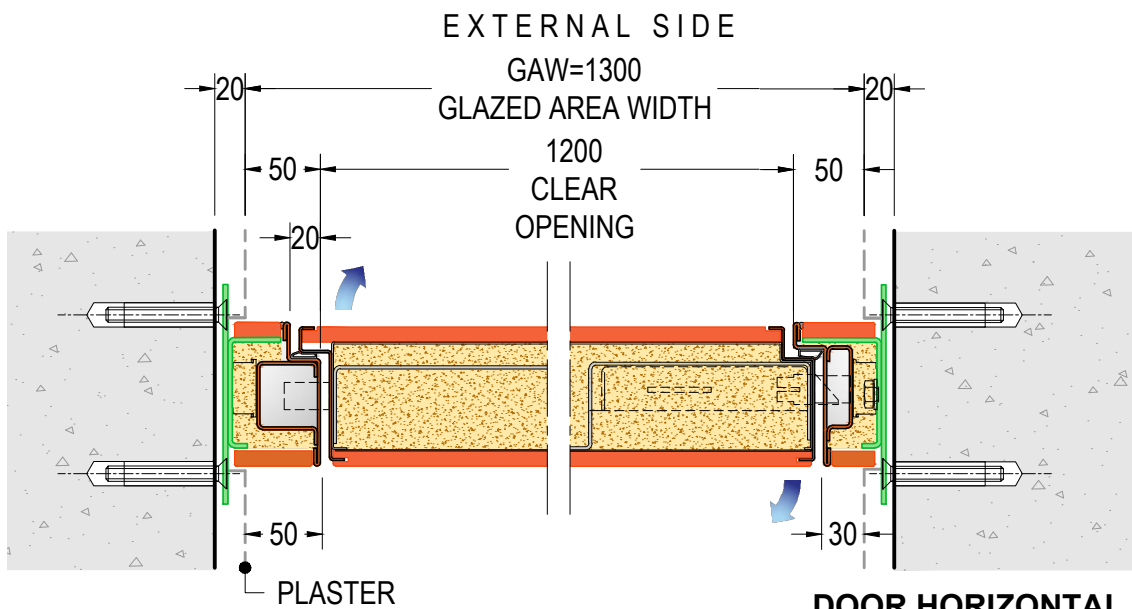

**DOOR HORIZONTAL SECTION
MODEL "B"**

ref. DOOR W=1200 - GLAZED AREA WIDTH GAW=1300

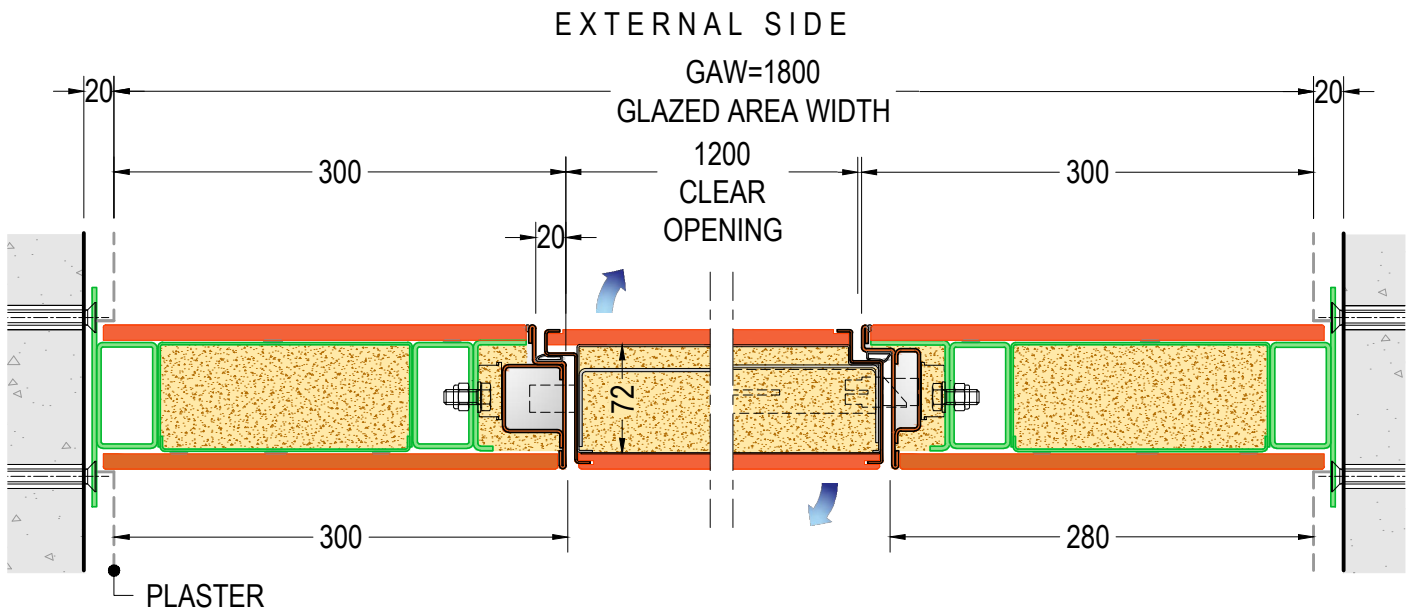

**DOOR HORIZONTAL SECTION
MODELS "E-F"**

ref. DOOR W=1200 - BLIND SIDE WINDOW 300
GLAZED AREA WIDTH GAW=1800

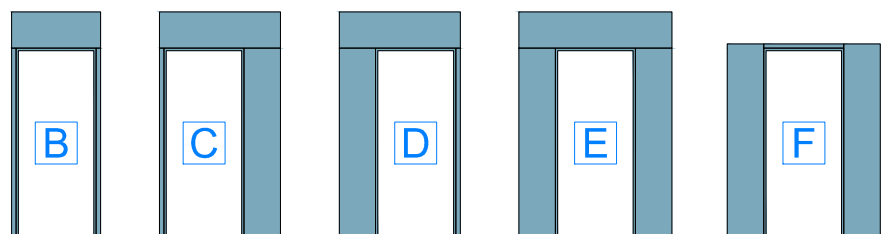

external side view



**SUBFRAME AND FRAME FOR DI.BIG PIVOT SECURITY DOOR 28.1
WITH BLIND SIDE AND TOP WINDOWS**

HORIZONTAL SECTIONS - scale 1:5

v1.7

DI.BI. PORTE BLINDATE Srl - Fano (PU) ITALY - www.dibigroup.com

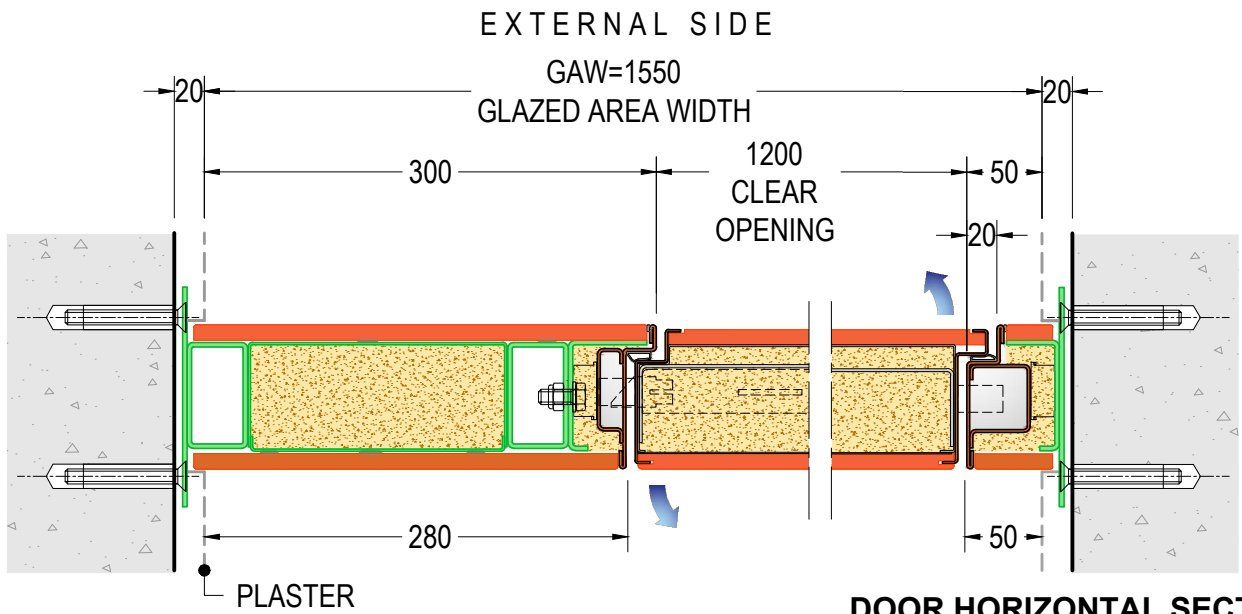

**DOOR HORIZONTAL SECTION
MODELS "C-G"**

ref. DOOR W=1200 - BLIND SIDE WINDOW 300
GLAZED AREA WIDTH GAW=1550

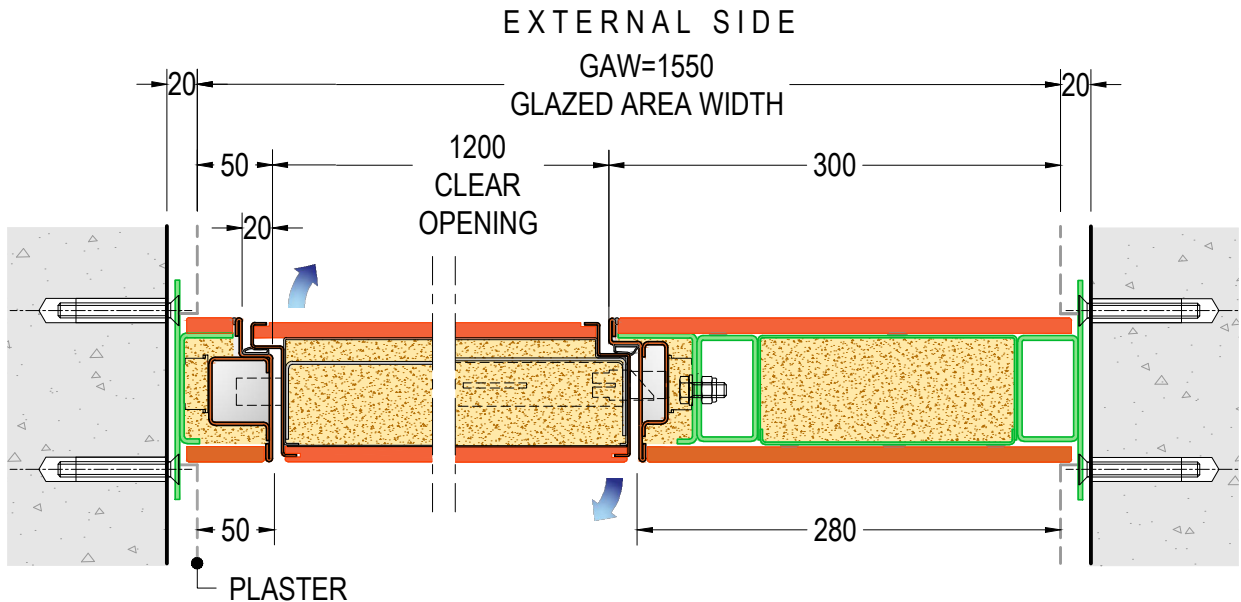

**DOOR HORIZONTAL SECTION
MODELS "D-H"**

ref. DOOR W=900 - BLIND SIDE WINDOW 300
GLAZED AREA WIDTH GAW=1550

GLAZED AREA:
MAXIMUM OVERALL DIMENSIONS
(GAWxGAH / GAHxGAW)
2900x3700 (CDE) 3700x2700 (FGH)

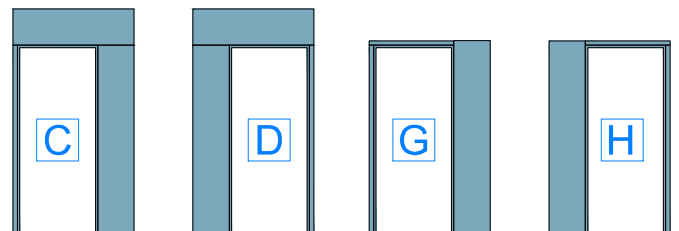

external side view



**SUBFRAME AND FRAME FOR DI.BIG PIVOT SECURITY DOOR 28.2
WITH BLIND SIDE AND TOP WINDOWS**

HORIZONTAL SECTIONS - scale 1:5

v1.7

DI.BI. PORTE BLINDATE Srl - Fano (PU) ITALY - www.dibigroup.com

EXTERNAL SIDE

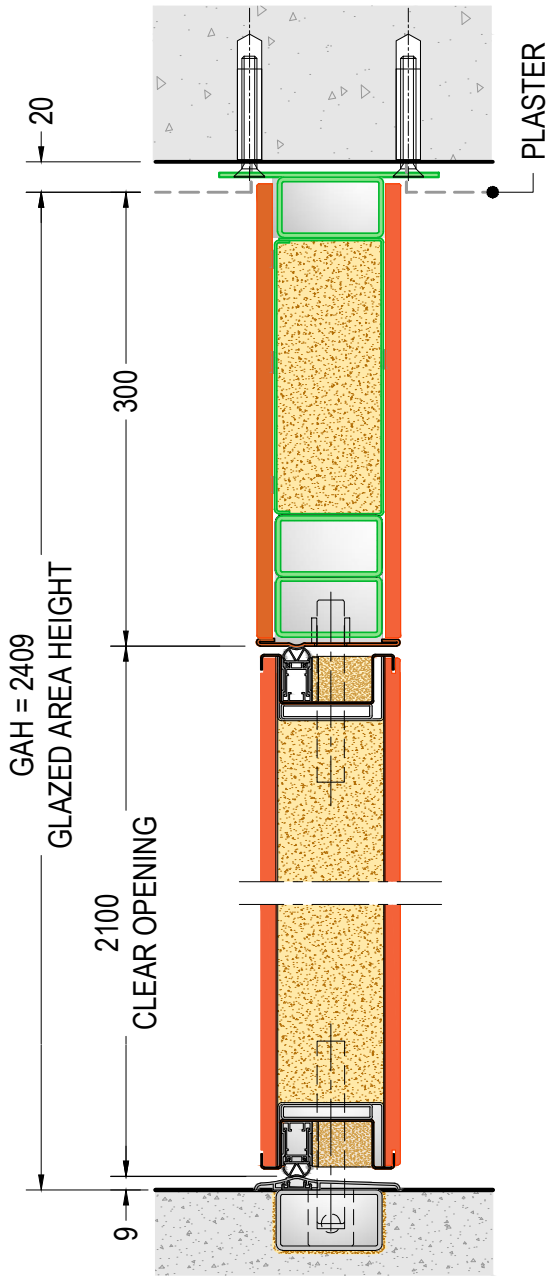

DOOR VERTICAL SECTION
MODELS "B-C-D-E"
 ref. DOOR H=2100
 BLIND TOP WINDOW 300
 GLAZED AREA HEIGHT GAH=2409

EXTERNAL SIDE

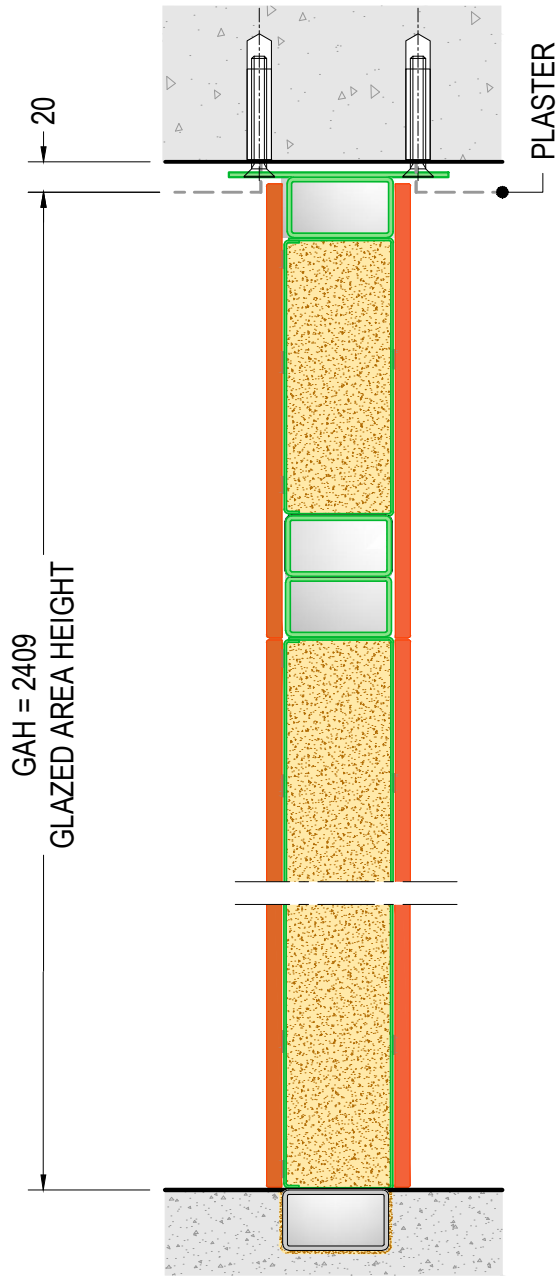

SIDE WINDOW VERTICAL SECTION
MODELS "C-D-E"
 ref. DOOR H=2100
 BLIND TOP WINDOW 300
 GLAZED AREA HEIGHT GAH=2409

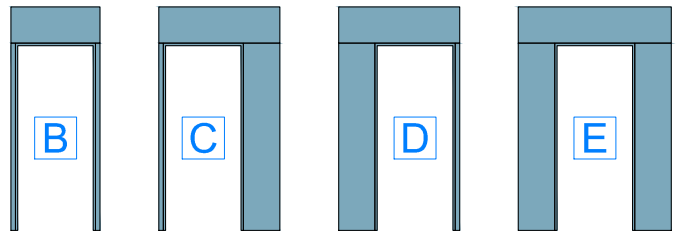

external side view



SUBFRAME AND FRAME FOR DI.BIG PIVOT SECURITY DOOR 28.3
WITH BLIND SIDE AND TOP WINDOWS

VERTICAL SECTIONS - scale 1:2

v1.7

DI.BI. PORTE BLINDATE Srl - Fano (PU) ITALY - www.dibigroup.com

EXTERNAL SIDE

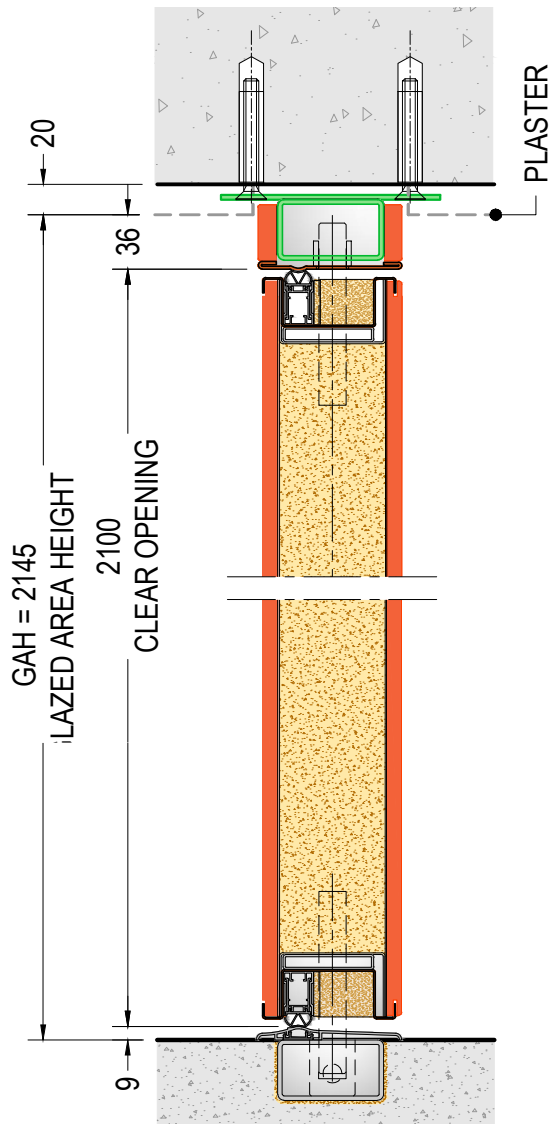

DOOR VERTICAL SECTION
MODELS "F-G-H"
 ref. DOOR H=2100
 GLAZED AREA HEIGHT GAH=2145

EXTERNAL SIDE

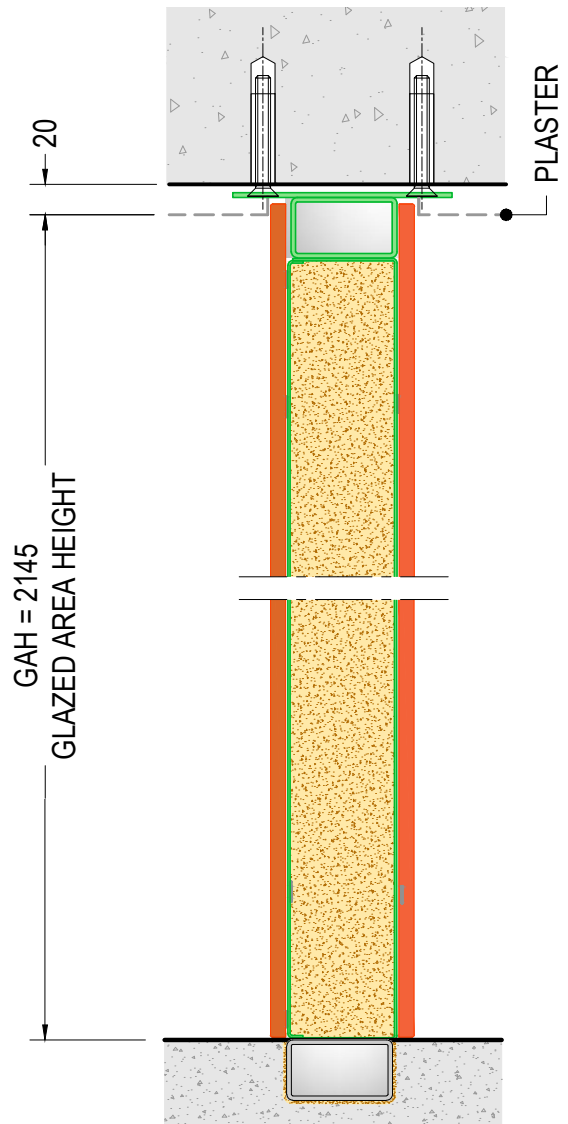

SIDE WINDOW VERTICAL SECTION
MODELS "F-G-H"
 ref. DOOR H=2100
 GLAZED AREA HEIGHT GAH=2145

GLAZED AREA:
 MAXIMUM OVERALL DIMENSIONS
 (GAWxGAH / GAHxGAW)
 2900x3700 (CDE) 3700x2700 (FGH)

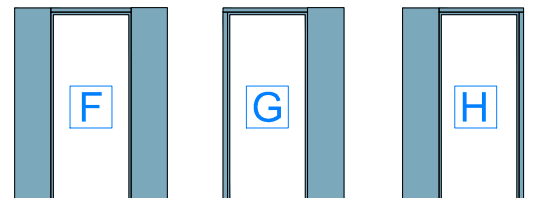

external side view



SUBFRAME AND FRAME FOR DI.BIG PIVOT SECURITY DOOR 28.4
WITH BLIND SIDE AND TOP WINDOWS

VERTICAL SECTIONS

v1.7

scale 1:2

© 2017 PORTA BLINDATE Srl - Fano (PU) ITALY - www.dibigroup.com



NOTES

DI.BI. PORTE BLINDATE Srl - Fano (PU) ITALY - www.dibigroup.com



DI.BI. PORTE BLINDATE Srl - Fano (PU) ITALY - www.dibigroup.com