

GOBO LIGHTS



GOBO LIGHTS
Handmade lights from Belgium



Nicolas Brevers

Self-taught and coming from the world of chemistry, this Belgian craftsman/designer designs his pieces with as much meticulousness as in a laboratory.

He loves numbers and perfect proportions, with which he plays using the timeless laws of hallowed geometry to adorn the space of his atomic shapes.

Shapes with pure, light and contemporary lines that evoke the very essence of natural elements.



Balance & Emotion



- They are a witness to a new language where the rational and the functional dialogue with the emotional to create a hypnotising and soothing universe that is the designer's own.

Always searching for equilibrium, Nicolas Brevers creates objects where lightness rhymes with precision, purity with architecture and art with design.



ABOUT THE DESIGNER

The Studio Gobo Lights



Gobolights conveys Nicolas Brevers' vision of design: playful kinetic art that results from research into aesthetics, harmony and balance.

The Gobolights design studio in Brussels specialises in the creation and production of upmarket contemporary lighting produced in small series and made to measure.



MADE IN BELGIUM

Gobolights is represented internationally by its presence at numerous fairs, such as the Salone del Mobile in Milan and Maison et Objets in Paris, and selected in 2016, 2017 and 2018 for the A design awards

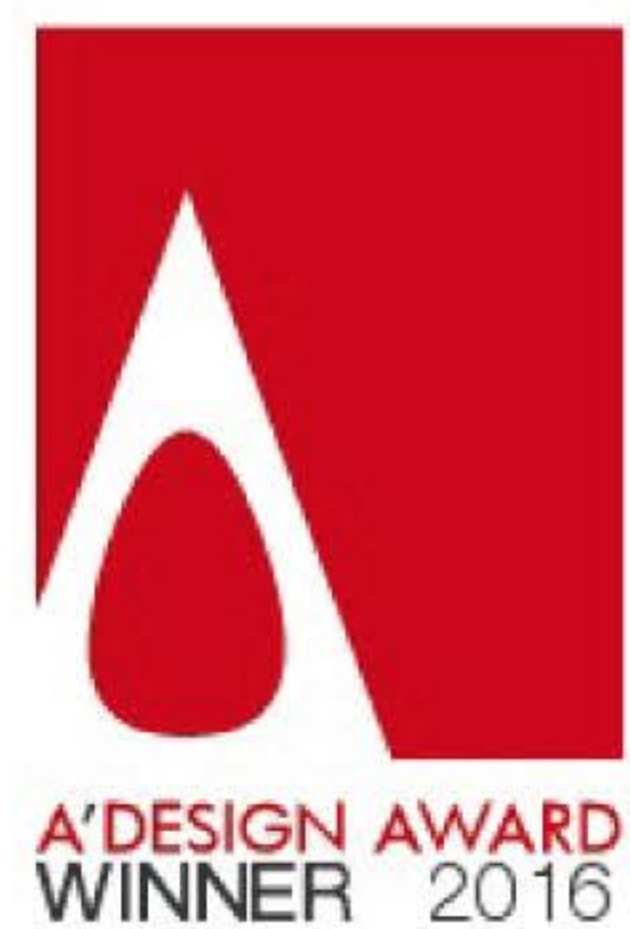



VALUES & **KNOW-HOW**



In order to offer quality lighting, it is essential for the brand to master all the stages of creation within the studio. In addition, the partners and collaborators are selected according to the values of the brand.

Gobolights also works in close collaboration with distributors and resellers, interior designer and individuals.



BETWEEN CRAFTSMANSHIP & NEW TECHNOLOGYt

09



In constant evolution, the studio combines traditional methods and new technologies.

Each component is created in-house and then made by us or one of our sub-contractors.

We can develop a new component or piece of glassware for a specific project.



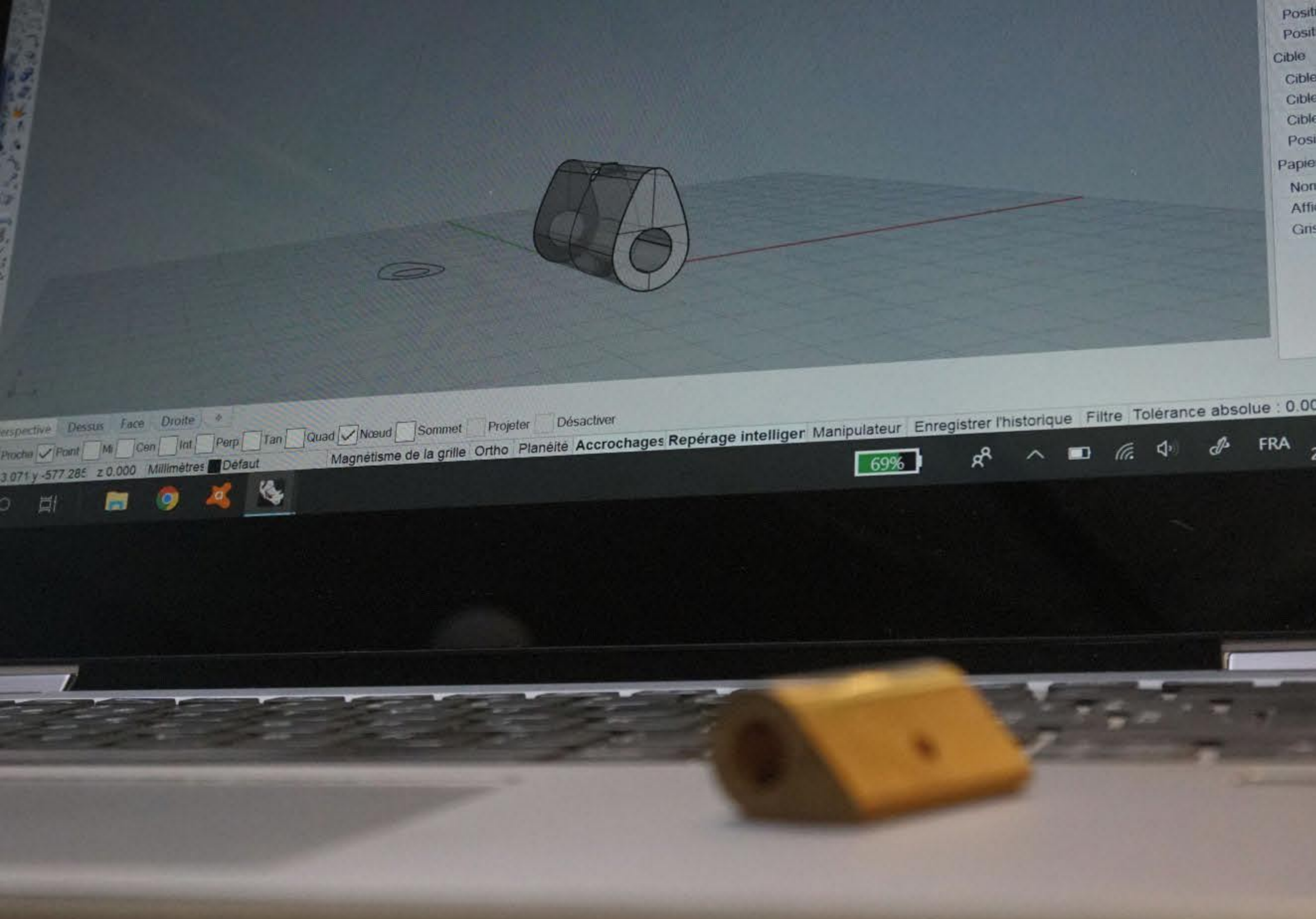

Our lights are assembled and tested in our workshop.

It also endeavours to encourage meetings and collaborations on the basis of varied projects.



VALUES AND KNOW-HOW





MADE JUST FOR YOU

A light from our existing collection can be adapted to suit the place in which it will be installed.

We have a large collection of comments.

The size of our lights can be modified and the components assembled in an infinite variety of possible combinations.



OUR MATERIALS



Our brass components can be oxidised to give them a patina.

Our hand-blown glass globes are available in different sizes (12 cm, 15 cm, 20 cm diameter) and different tints.

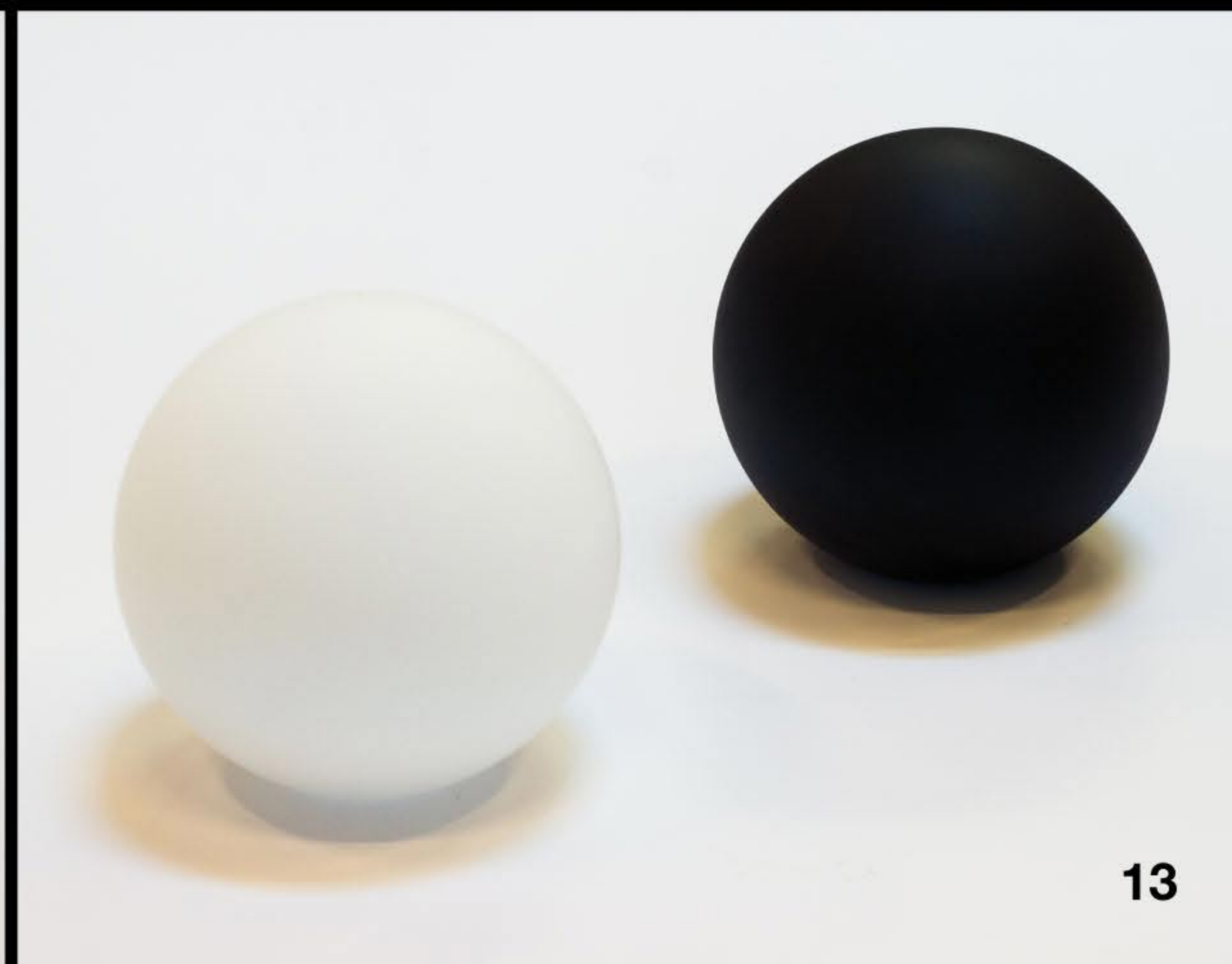

ADAPTIVE LIGHT

We do not use integrated lighting systems in our lights but rather standard LED bulbs, which can be replaced at the end of their life.

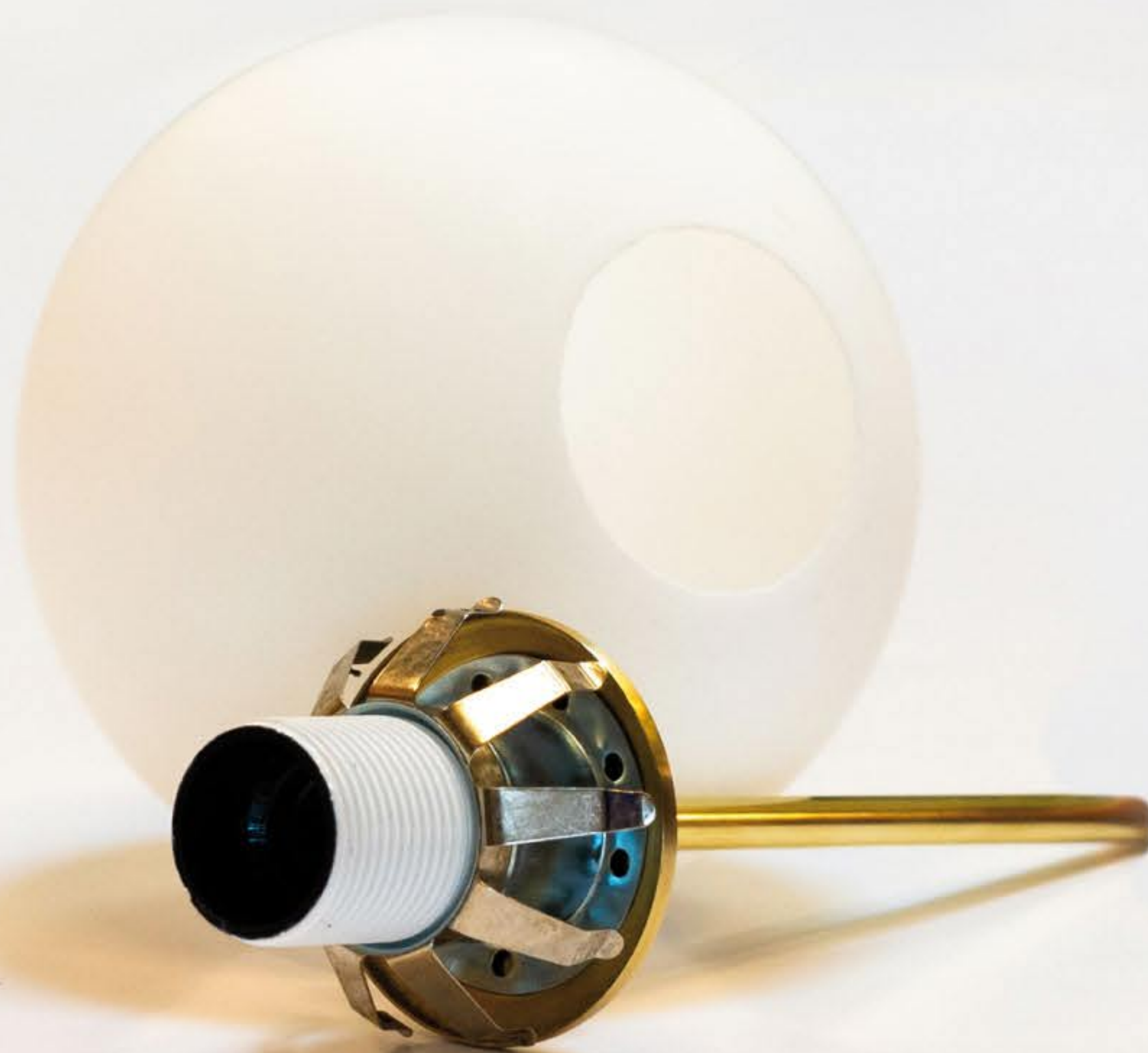

You can choose the heat (2,700–6,000 Kelvin) and the intensity of your light bulbs (200–1,000 lumens).

Our lights are compatible with European and American standard light bulbs and with an LED dimmer switch.

A PROJECT ?



Whether it is for housing projects or those for hotels, bars, restaurants or shops, Gobolights is able to offer lights tailored to your needs.

We are available to imagine a new creation developed in collaboration with you!



CASE STUDY



We will study your request on the basis of a 3D image, a sketch, a photograph or an appointment in our studio or on your premises and send you a reply regarding the feasibility of your project as soon as possible.

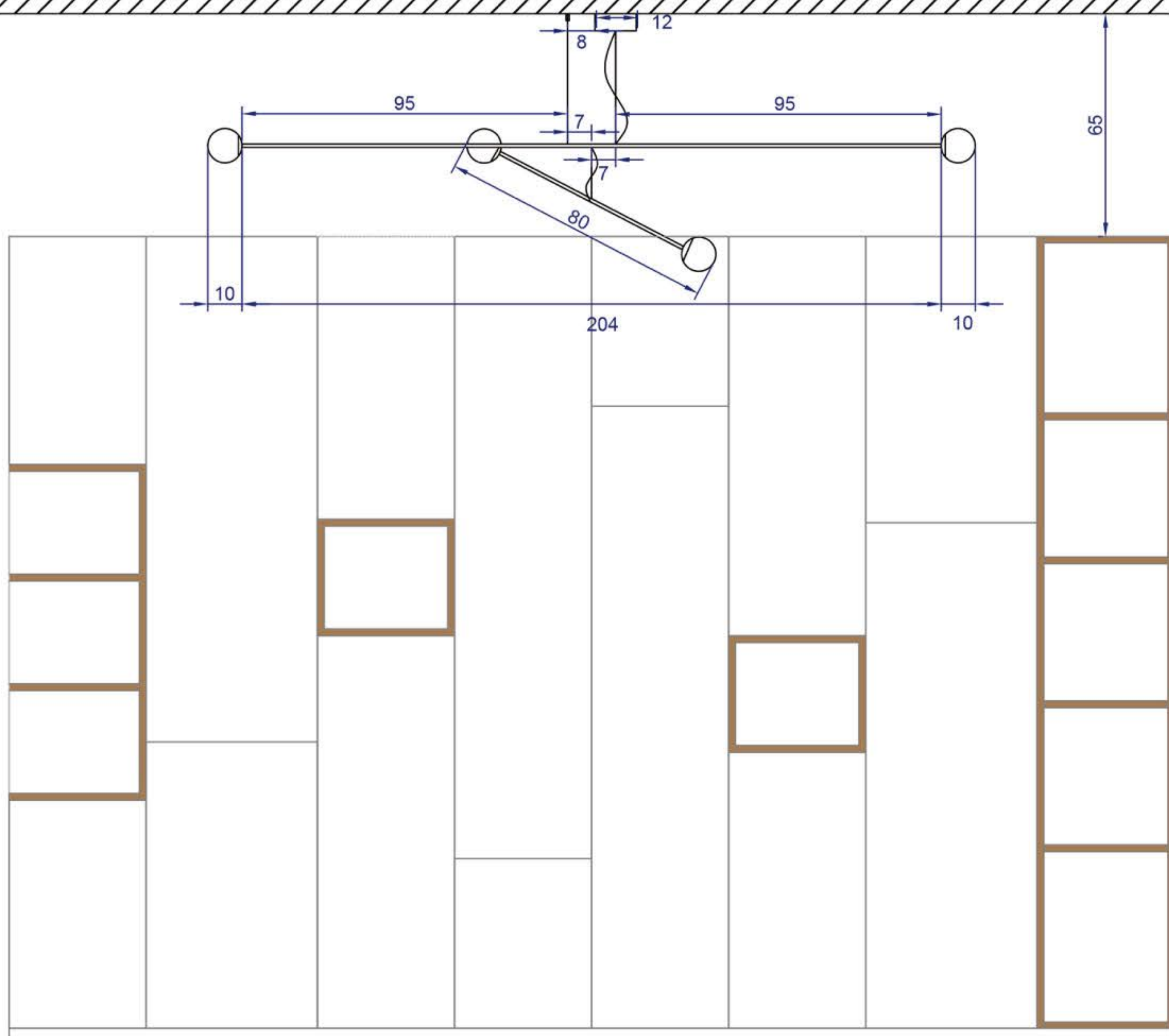

PR 2

A proposal with the technical details, a 3D image and an estimate of the costs will then be forwarded to you.

Once you have accepted it and lodged the requested down payment, your light will be manufactured in two to four weeks.

INSTALLATION & DELIVERY



We can assist you with the delivery and installation, if necessary.

Each light is delivered with its technical sheet, its 3D model and instructions for its installation. Our documentation is available on our website (technical details and instructions).



MONTAGE / ASSEMBLY

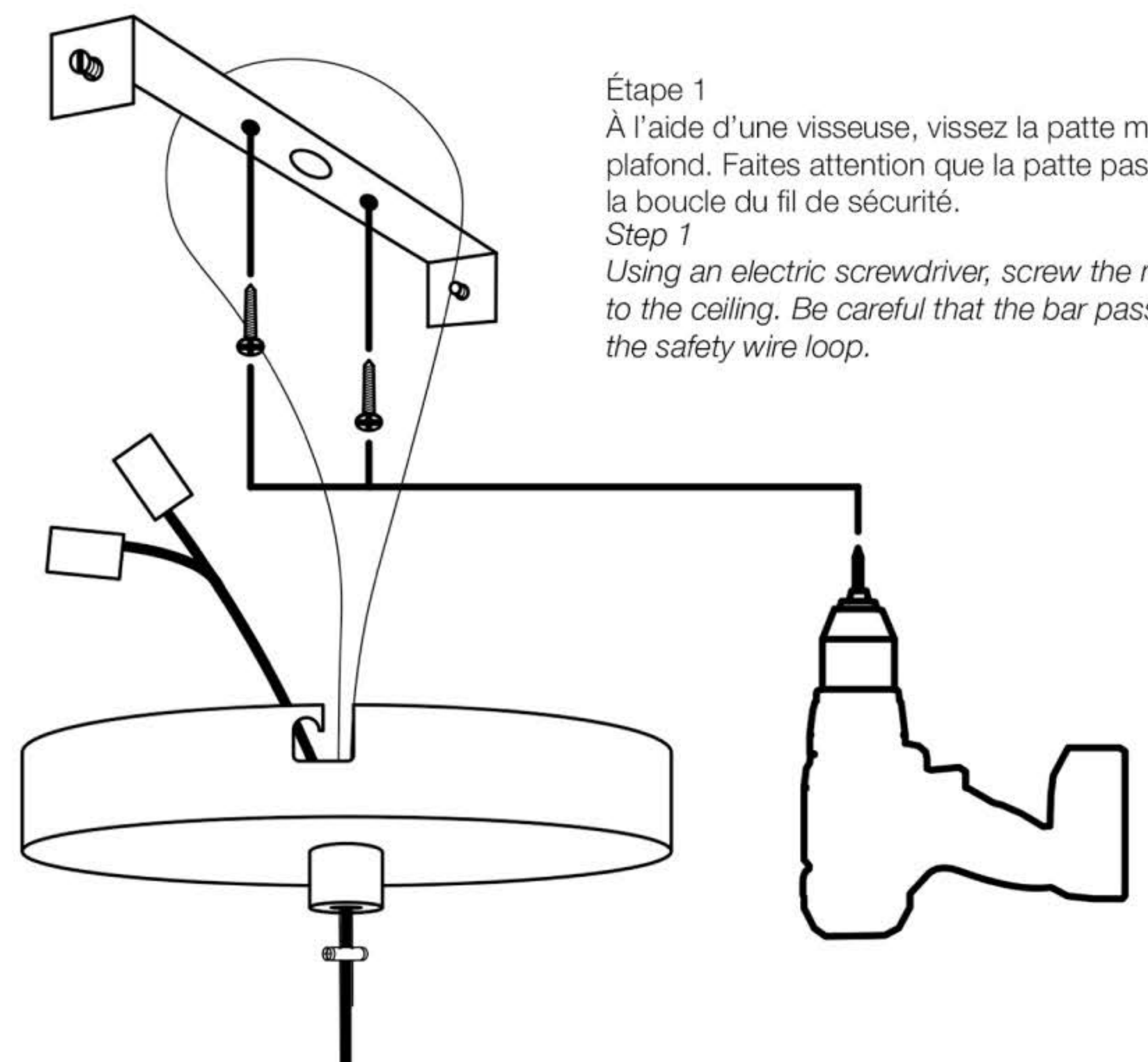

Étape 1

À l'aide d'une visseuse, vissez la patte métallique au plafond. Faites attention que la patte passe bien dans la boucle du fil de sécurité.

Step 1

Using an electric screwdriver, screw the metallic bar to the ceiling. Be careful that the bar pass through the safety wire loop.

BRASS & OPALINES COLLECTION

18



Inspired by art déco movement, "Brass and Opaline" collection is an ode to simplicity combined with luxurious finishes.

Lighting with pure lines where geometric shapes and curves are honoured.

Brass and glass are the only two materials in this collection.



NO01

NOTOS

Notos, The master of the violent south wind.

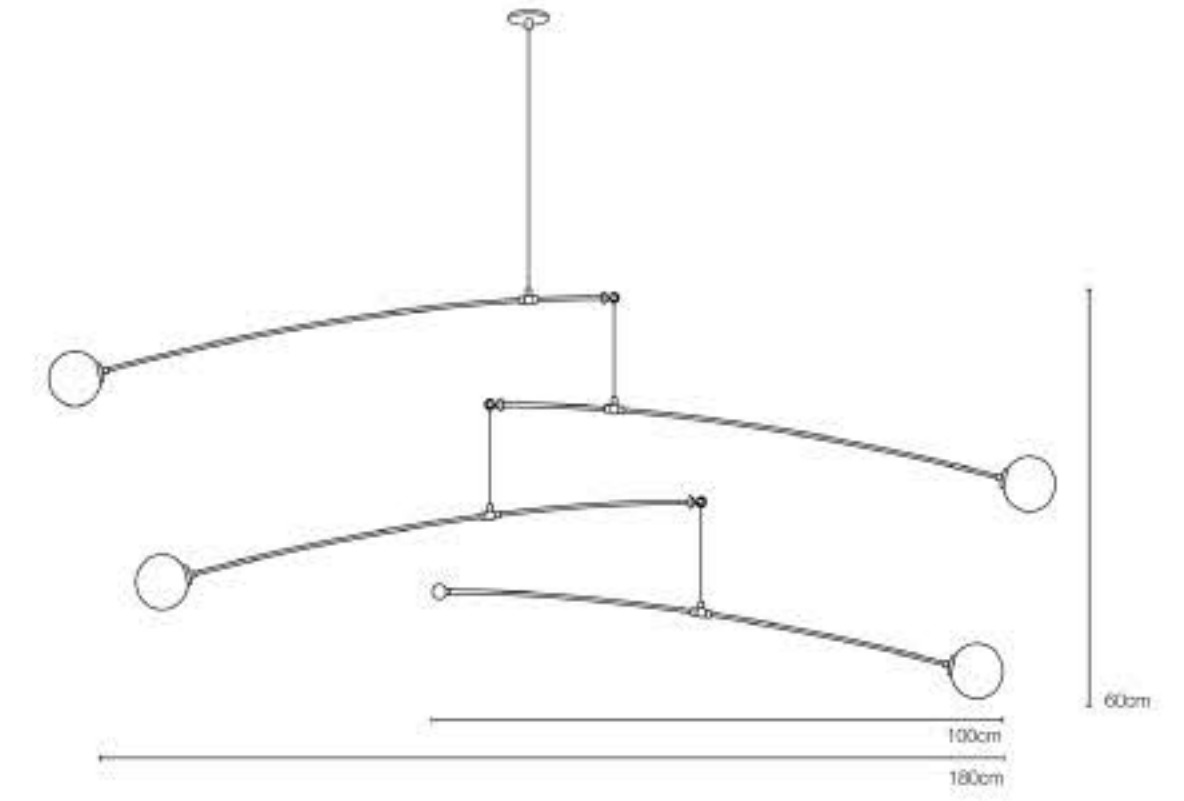

180 cm I
180 cm L
60 CM H



Brushed Brass



Mouthblow Opal
Mat Glass



ø 12 & 15 cm



LED E14



450-800 Lumens



2700-6000 Kelvin



Dimmable



Norme CE



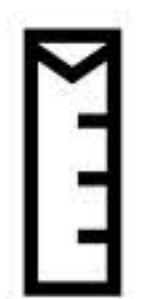

180 cm I
180 cm L
60 CM H



Brushed Brass



Mouthblow Opal
Mat Glass



ø 12 & 15 cm



LED E14



450-800 Lumens



2700-6000 Kelvin



Dimmable



Norme CE

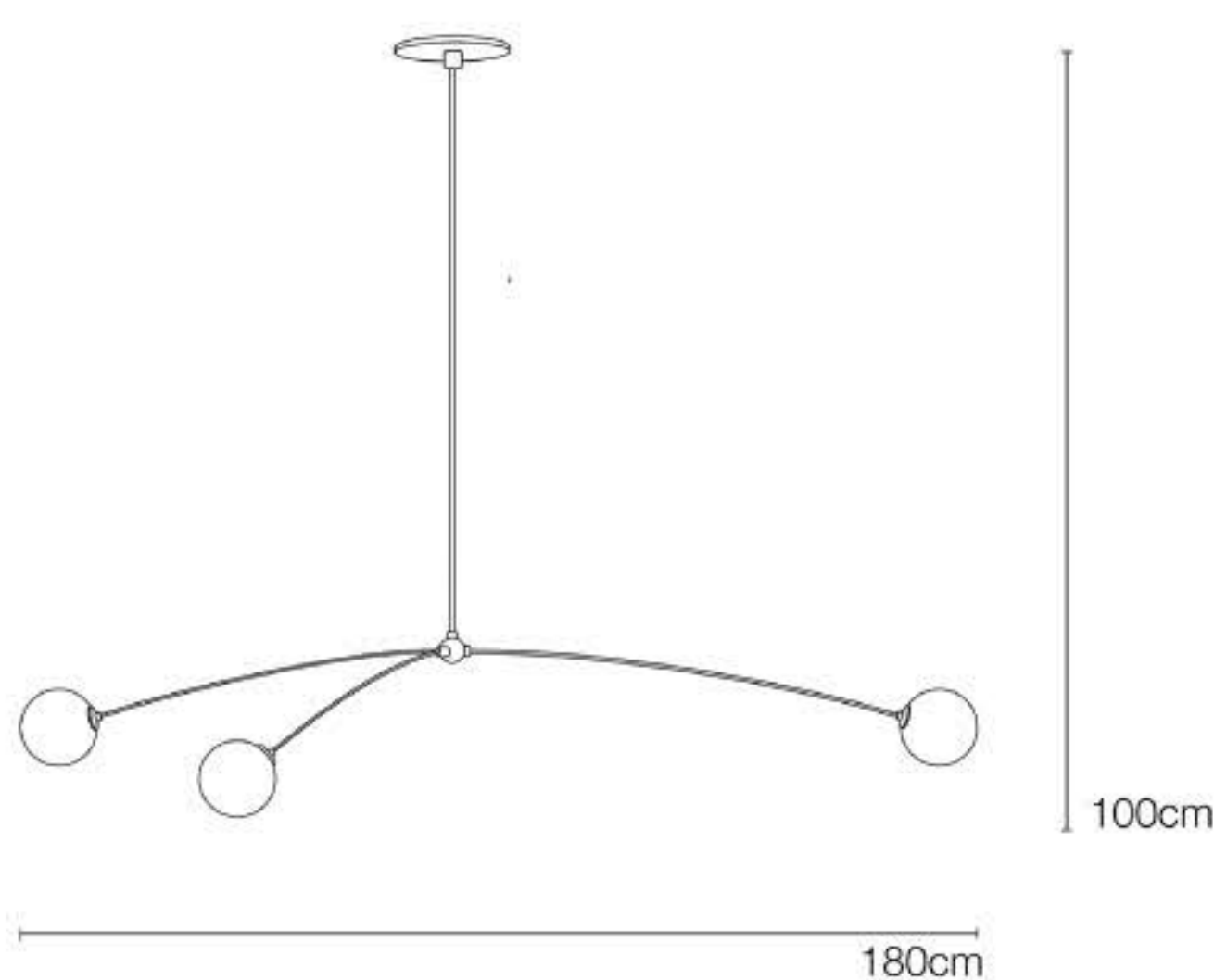

EO01

ÉOLE

Goddess of the fair anger, the revenge and the balance.



OU01

OUUREA

In Greek mythology, the Ourea were progeny of Gaia, members of the Greek primordial deities.

Who were the first-born elemental gods and goddesses.

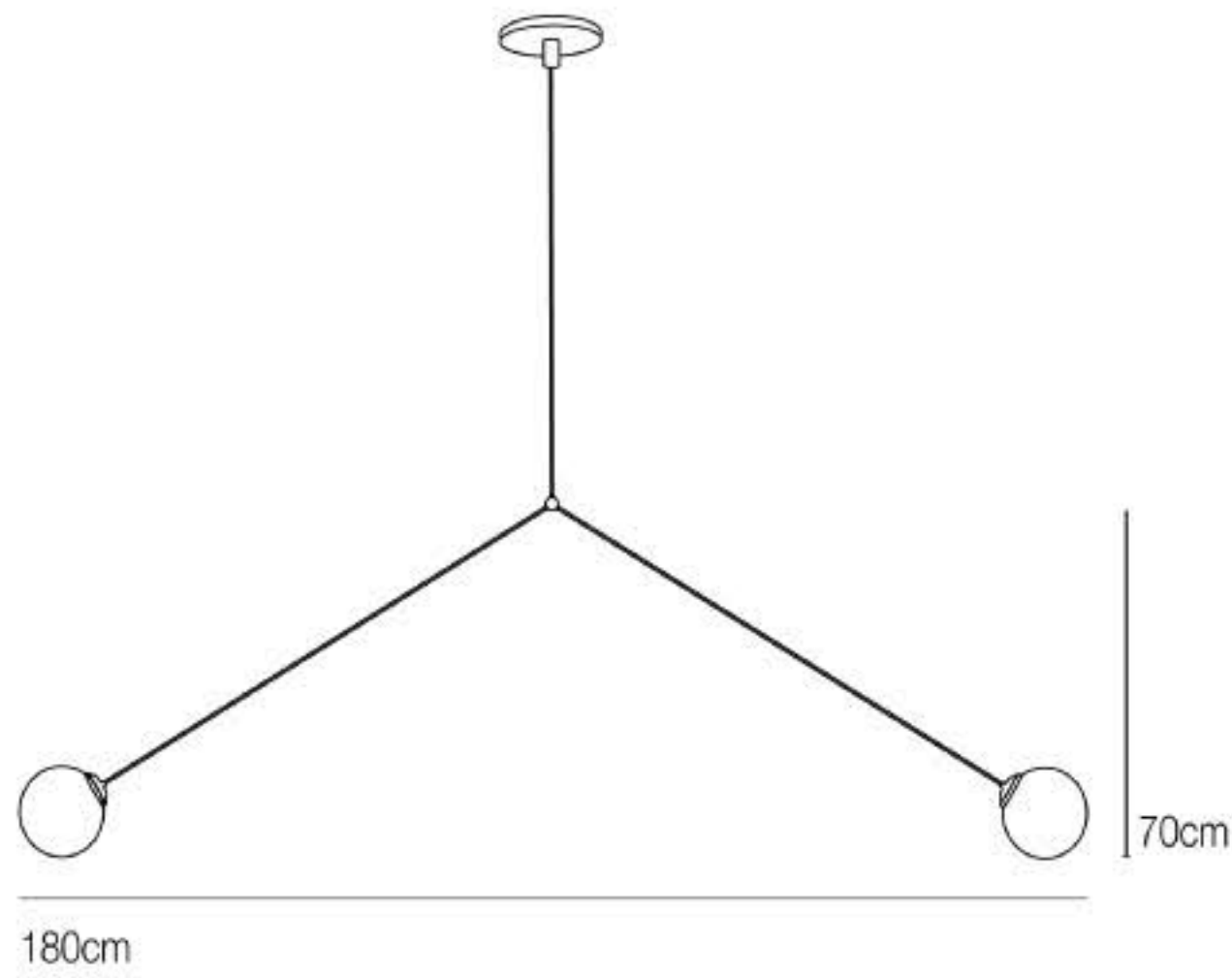

12 cm I
180 cm L
50 CM H



Brushed Brass



Mouthblow Opal
Mat Glass



ø 12 & 15 cm



LED E14



450-800 Lumens

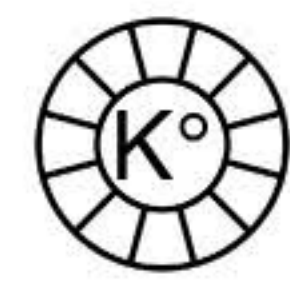

2700-6000 Kelvin



Dimmable



Norme CE







200 cm I
200 cm L
60 CM H



Brushed Brass

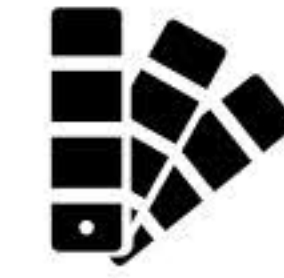

Mouthblow Opal
Mat Glass



30 cm



LED E14



450-800 Lumens



2700-6000 Kelvin



Dimmable



Norme CE

EU01

EUROS

One of the powerful god of the Wind

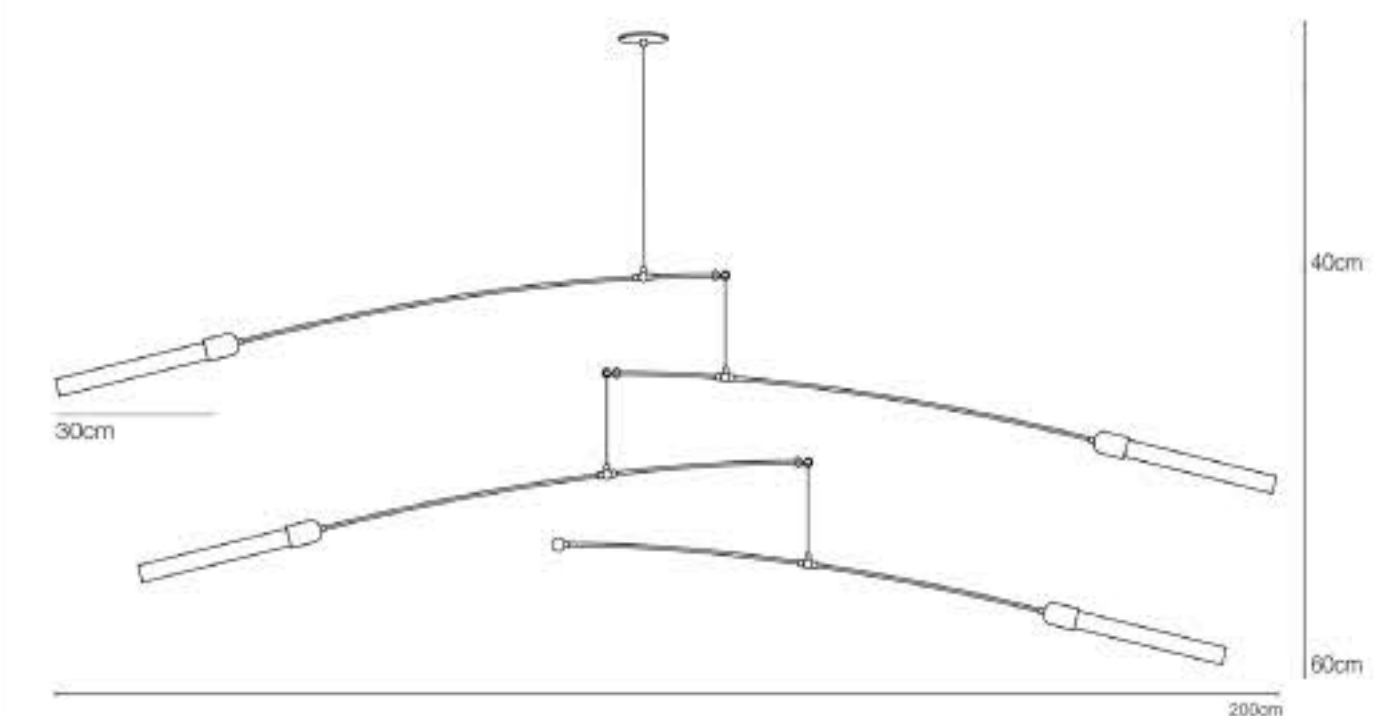



DI01

DIOSCURIS

In Greek mythology, Castor and Pollux, called Dioscuri, are the twin sons of Leda.

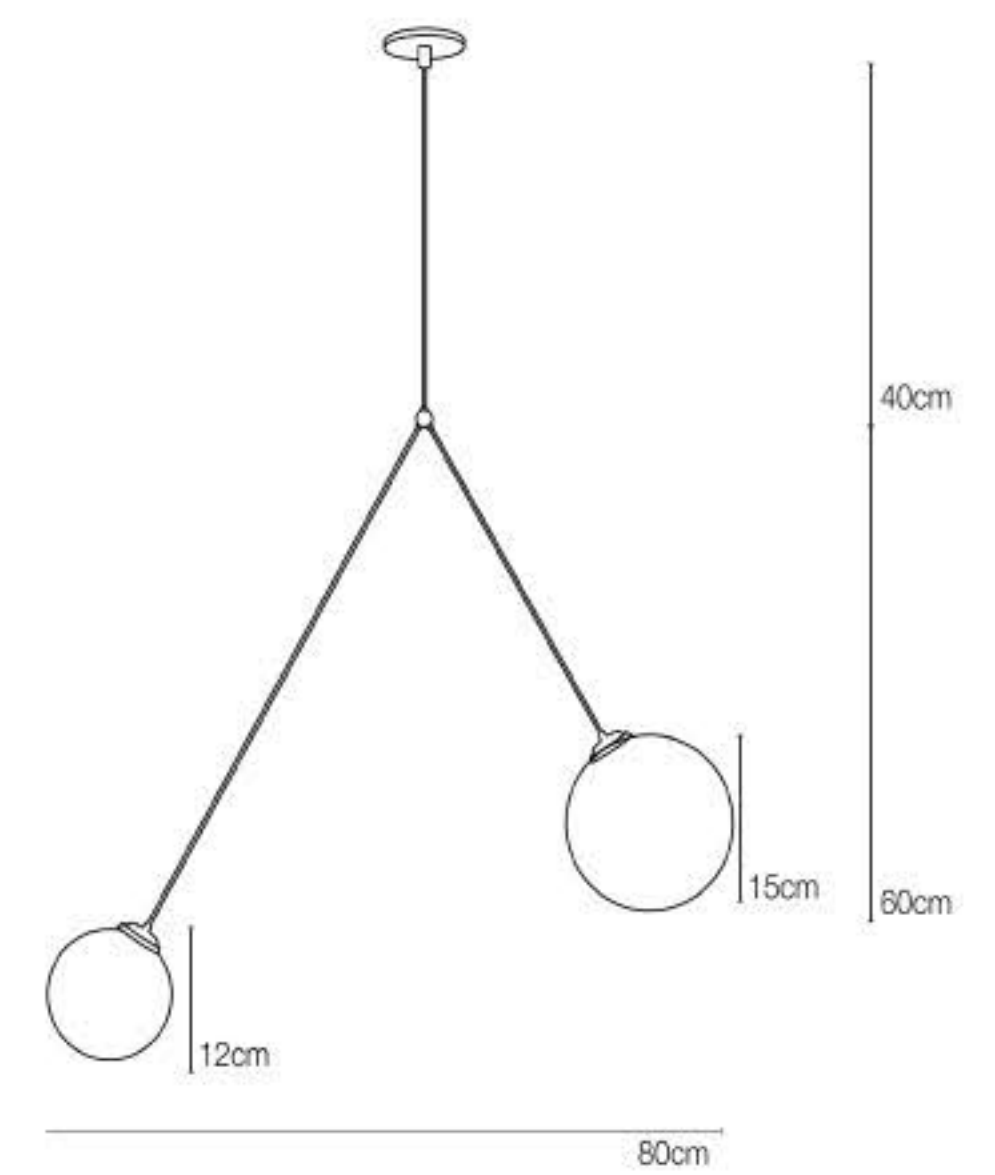

12 cm I
80 cm L
100 CM H



Brushed Brass



Mouthblow Opal
Mat Glass



ø 12 & 15 cm



LED E14



450-800 Lumens



2700-6000 Kelvin



Dimmable



Norme CE



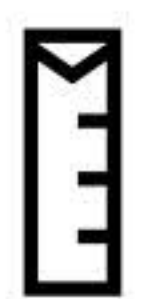

100cm I
100 cm L
12 CM H



Brushed Brass



Mouthblow Opal
Mat Glass



ø 12 & 15 cm



LED E14



450-800 Lumens

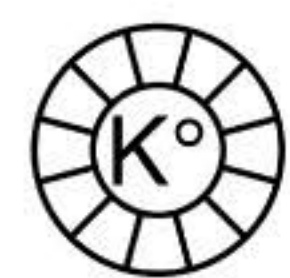

2700-6000 Kelvin



Dimmable



Norme CE

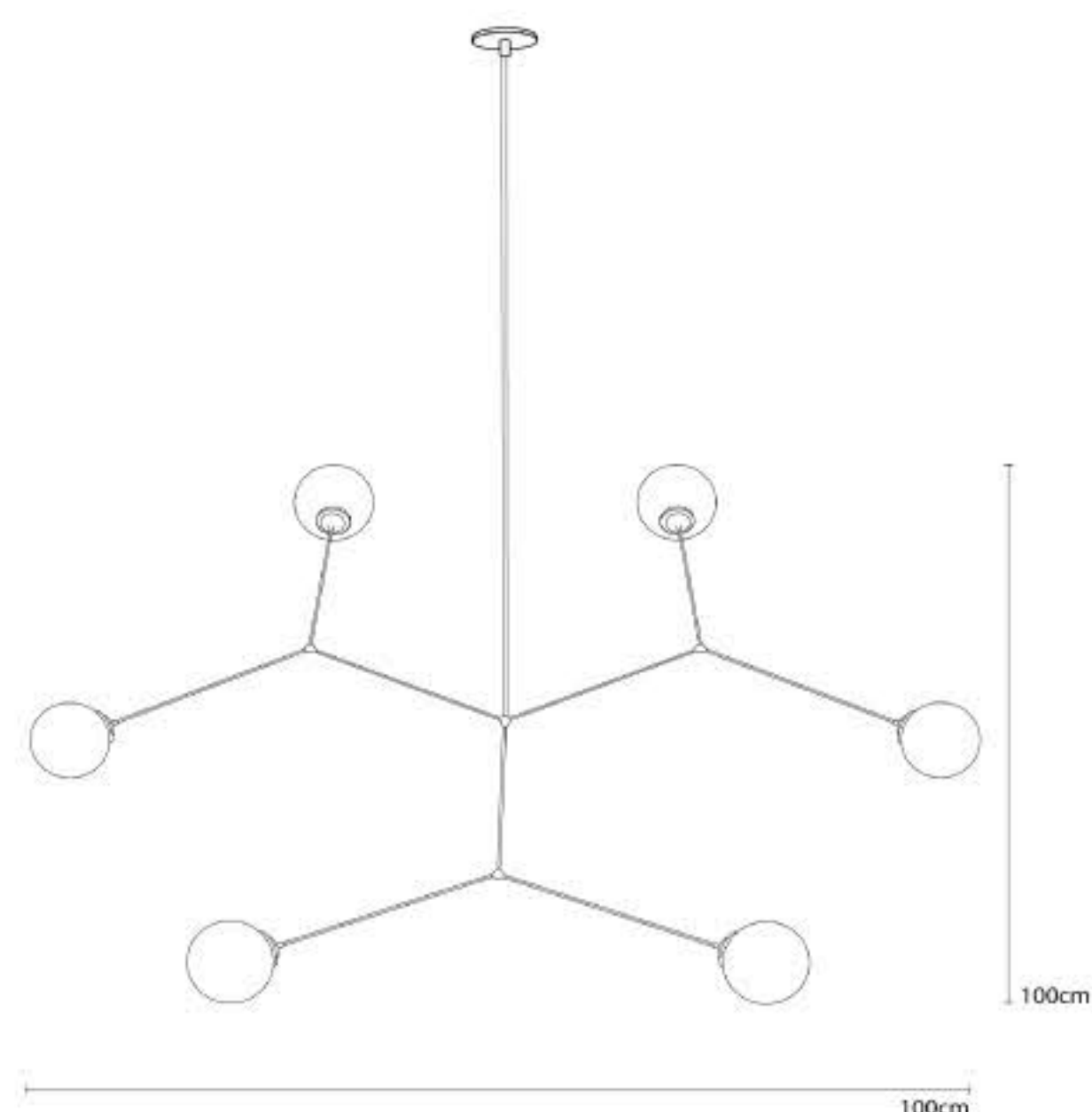

CH01

CHIONE

Chione is a goddess , daughter of Boreas. She is associated to the winter.



JU01

JUPITER

Jupiter say the poets is the father, the king of gods and men.
He reigns in Olympus and with a nod shakes the universe.

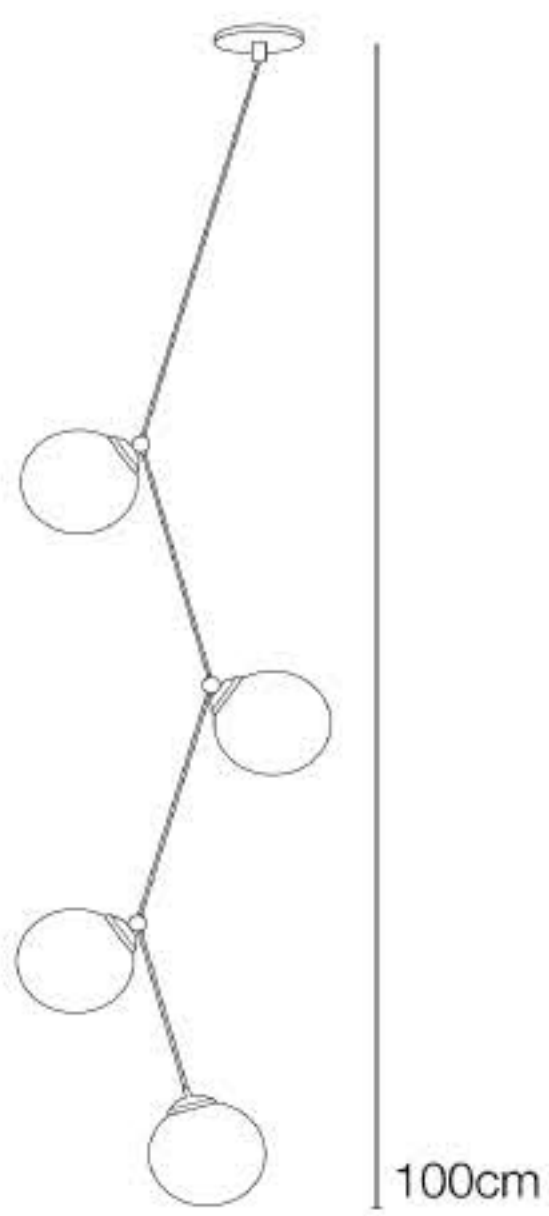

12 cm I
30cm L
95cm H



Brushed Brass



Mouthblow Opal
Mat Glass



ø 12 & 15 cm



LED E14



450-800 Lumens

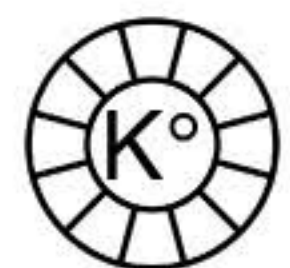

2700-6000 Kelvin



Dimmable



Norme CE







60cm L
60 cm L
75 CM H



Brushed Brass



Mouthblow Opal
Mat Glass



ø 20 cm



LED E14



450-800 Lumens



2700-6000 Kelvin



Dimmable



Norme CE

AT01

ATLAS

Atlas is a Titan who is condemned to sustain the sky for eternity.

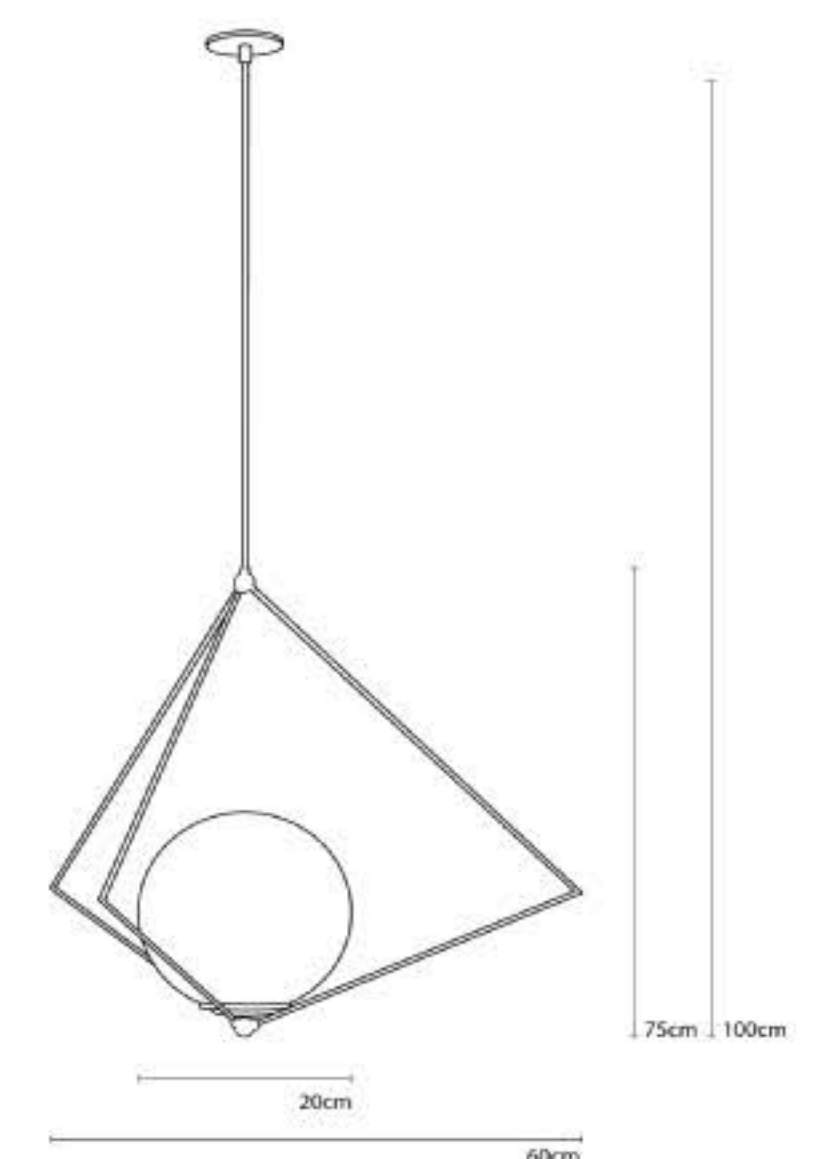



NE01

NÉMÉSIS

Nemesis is the Greek Goddess of fair anger, revenge and balance which has inspired this light.

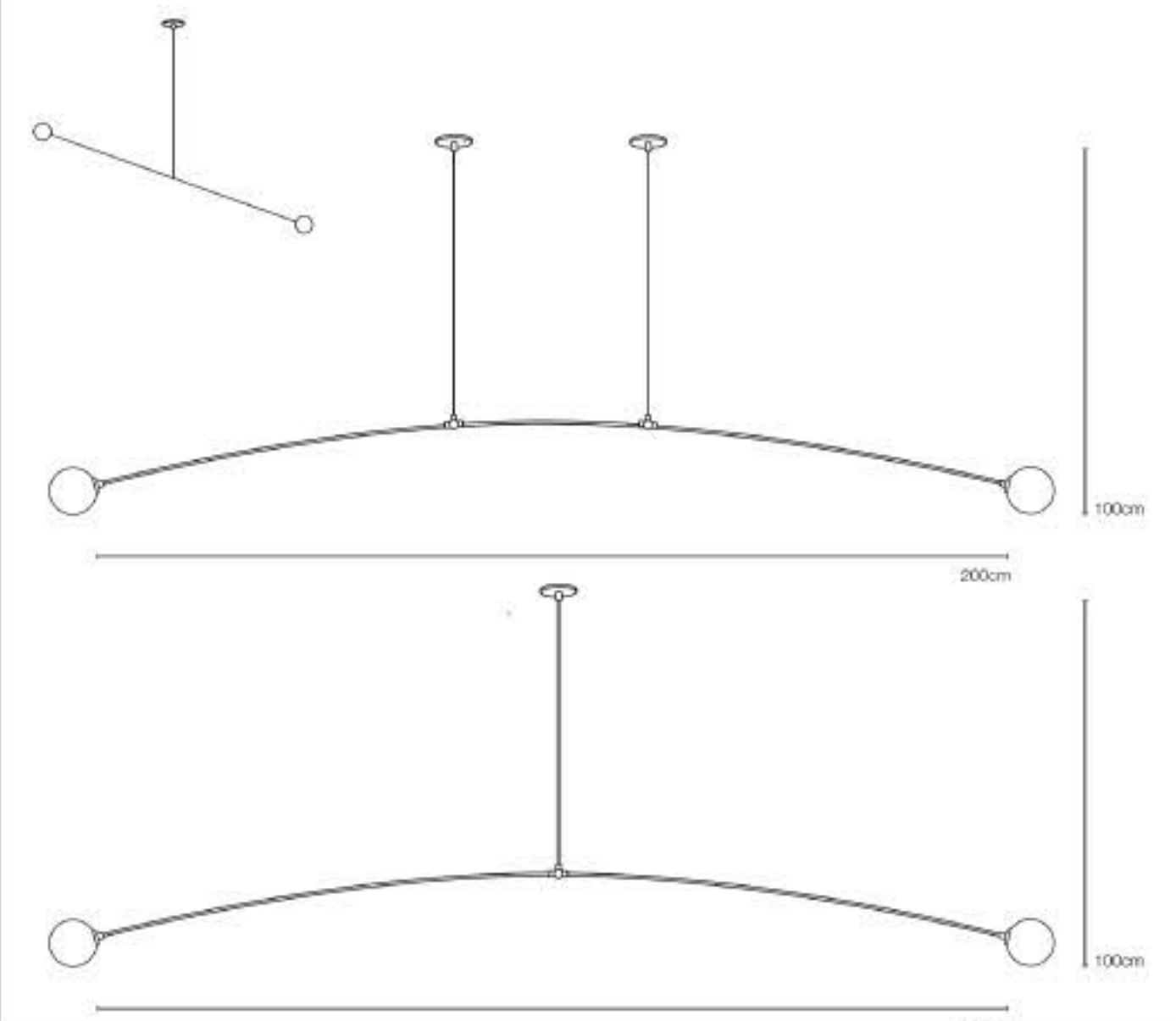

12 cm I
200cm L
12cm H



Brushed Brass



Mouthblow Opal
Mat Glass



ø 12 & 15 cm



LED E14



450-800 Lumens



2700-6000 Kelvin



Dimmable



Norme CE





100 cm I
100 cm L
100 cm H



Brushed Brass



Mouthblow Opal
Mat Glass



ø 12 & 15 cm



LED E14



450-800 Lumens

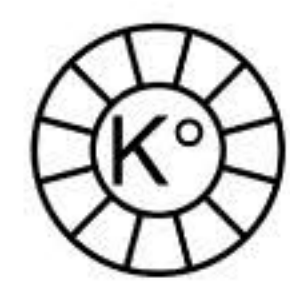

2700-6000 Kelvin



Dimmable



Norme CE

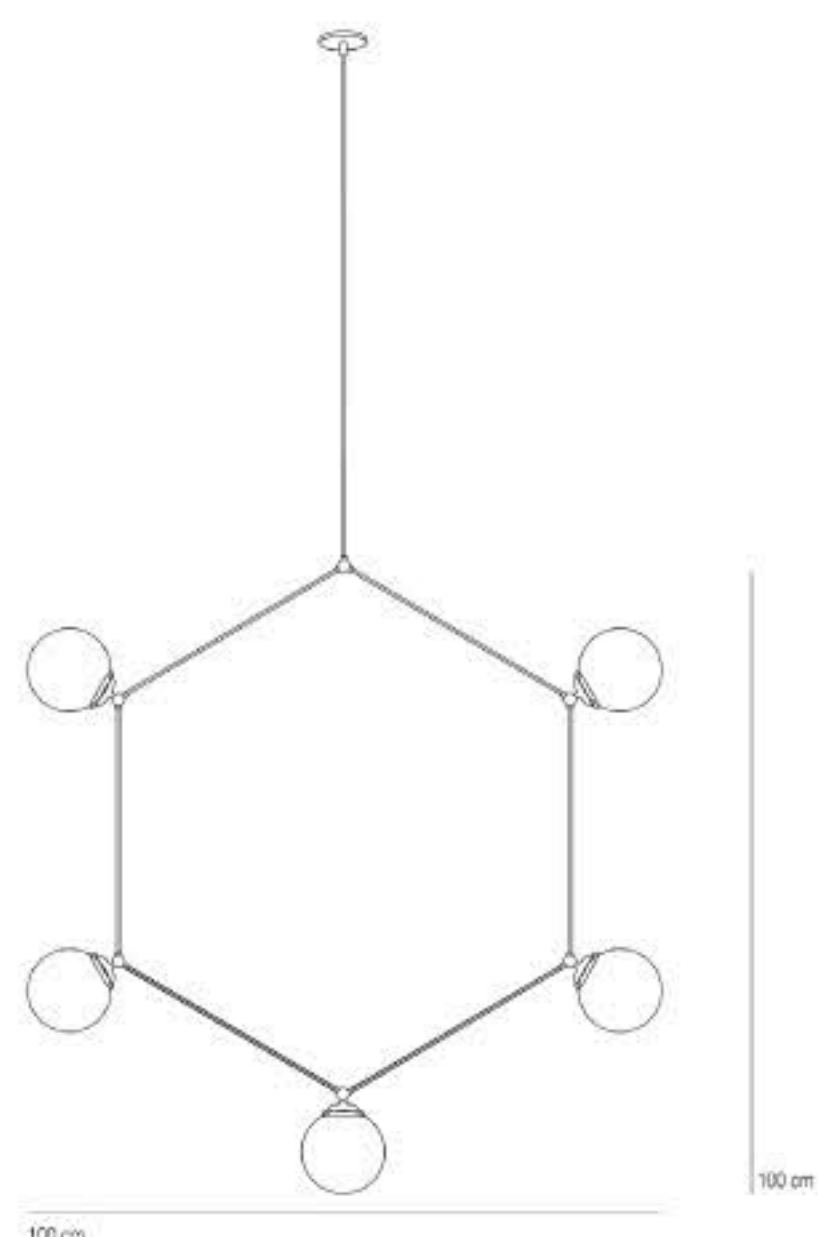

AC01

ACHILLE

The legendary hero of the Troy War .





12 cm I
75 cm L
75 cm H



Brushed Brass



Mouthblow Opal
Mat Glass



ø 12 & 15 cm



LED E14



450-800 Lumens



2700-6000 Kelvin



Dimmable



Norme CE

SE01

SÉLÉNÉ

Selene, the brightest object in the darkness of the night.

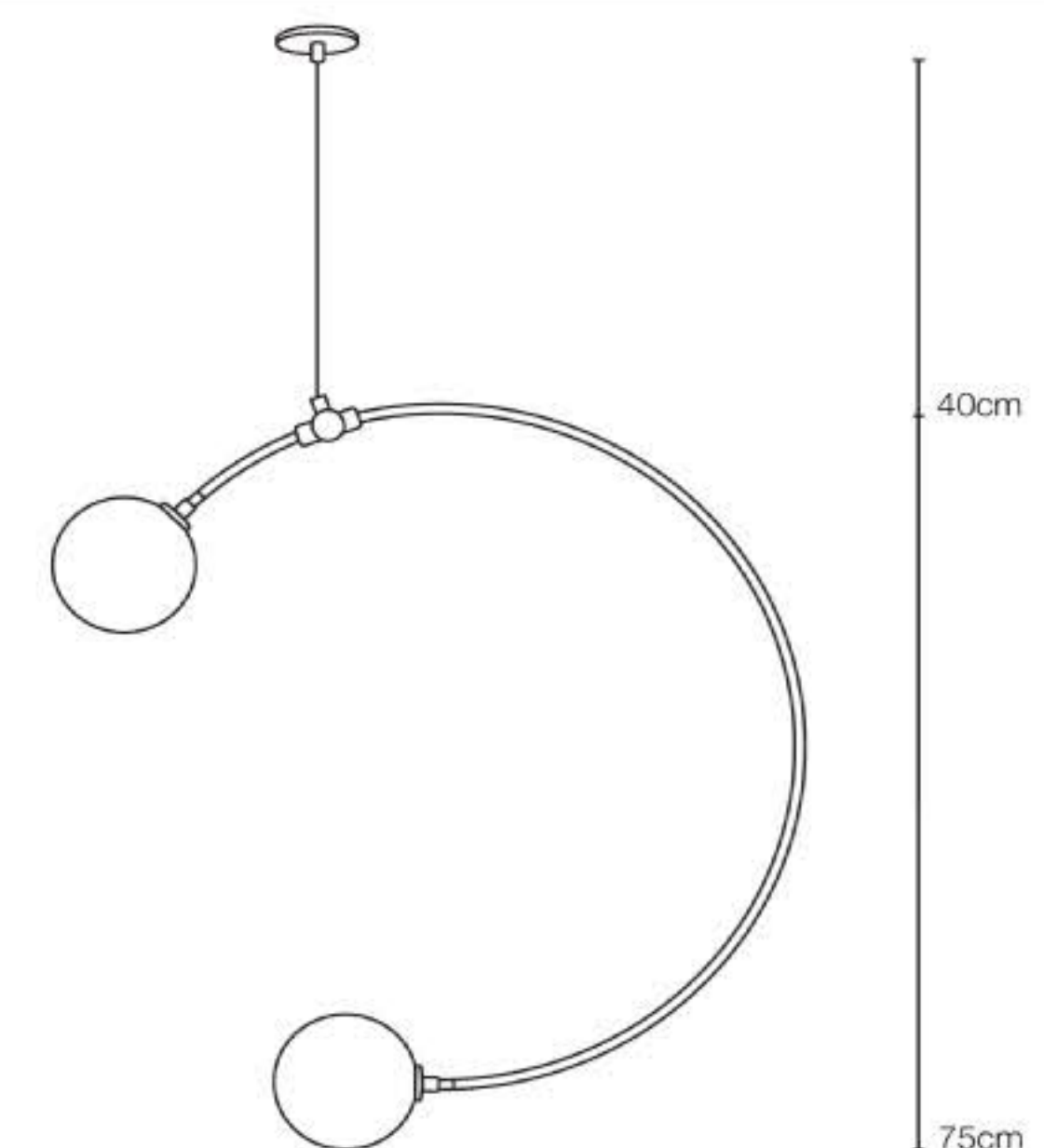



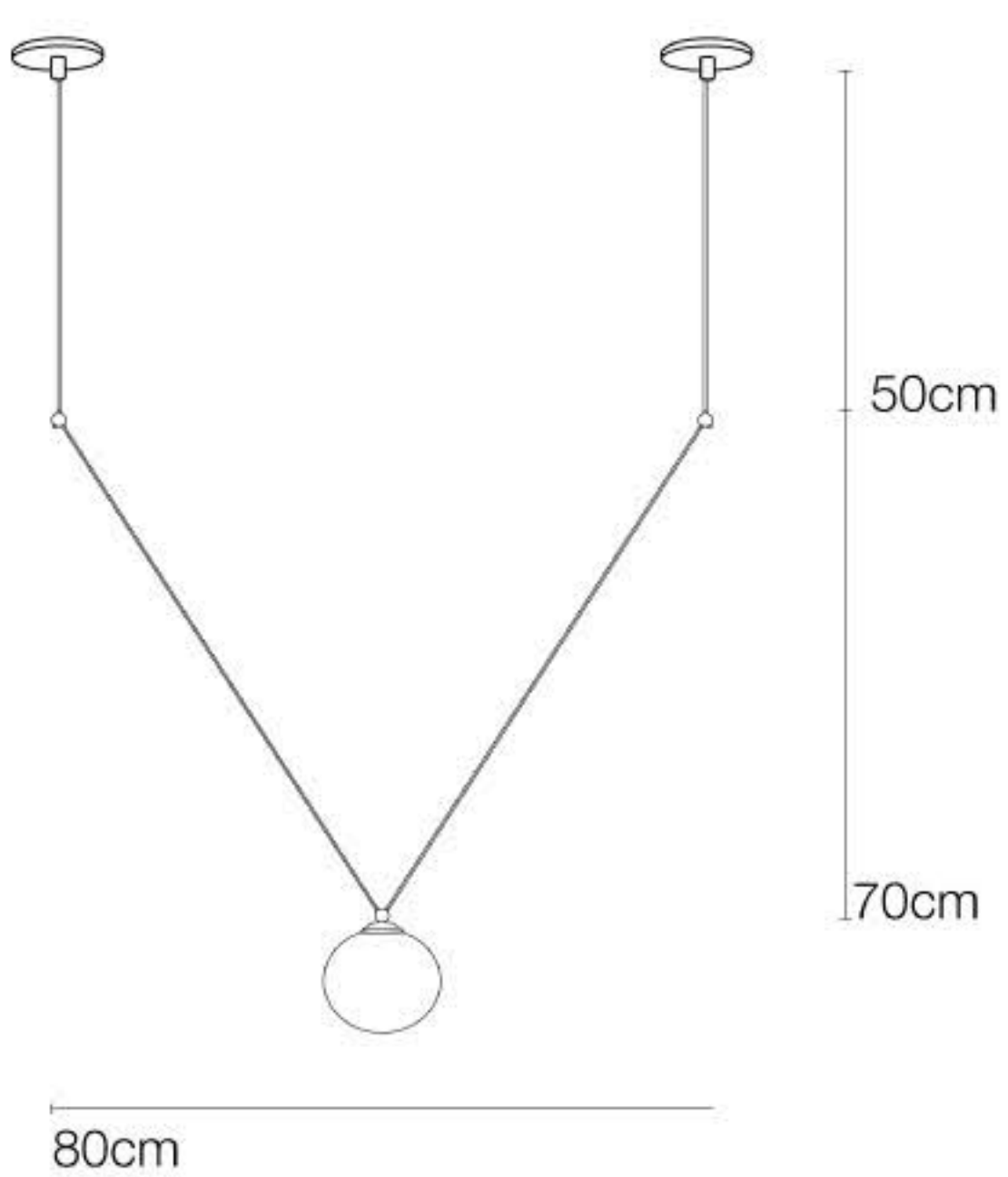

VE01

VENUS I

Venus is a Roman goddess who comes from a wave of the sea. She also is the goddess of beauty.



12 cm I
80 cm L
70 cm H



Brushed Brass



Mouthblow Opal
Mat Glass



∅ 12 & 15 & 20 cm



LED E14



450-800 Lumens

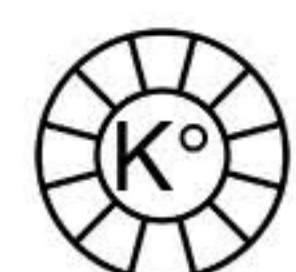

2700-6000 Kelvin



Dimmable



Norme CE



VE02

VENUS II

Venus is a Roman goddess who comes from a wave of the sea. She also is the goddess of beauty.

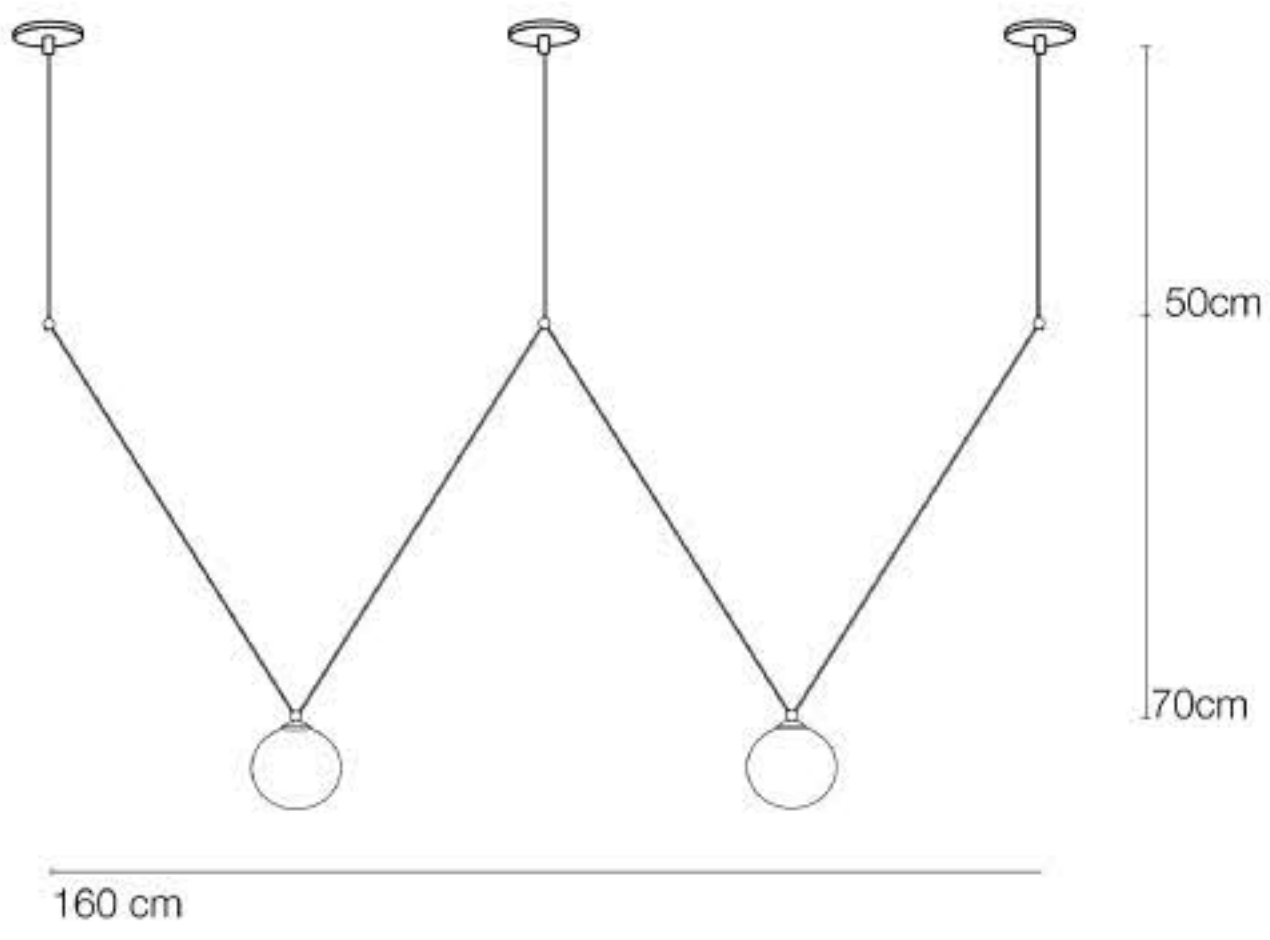

12 cm I
160 cm L
70 cm H



Brushed Brass



Mouthblow Opal
Mat Glass



∅ 12 & 15 & 20 cm



LED E14



450-800 Lumens



2700-6000 Kelvin



Dimmable



Norme CE



VE03

VENUS III

Venus is a Roman goddess who comes from a wave of the sea. She also is the goddess of beauty.

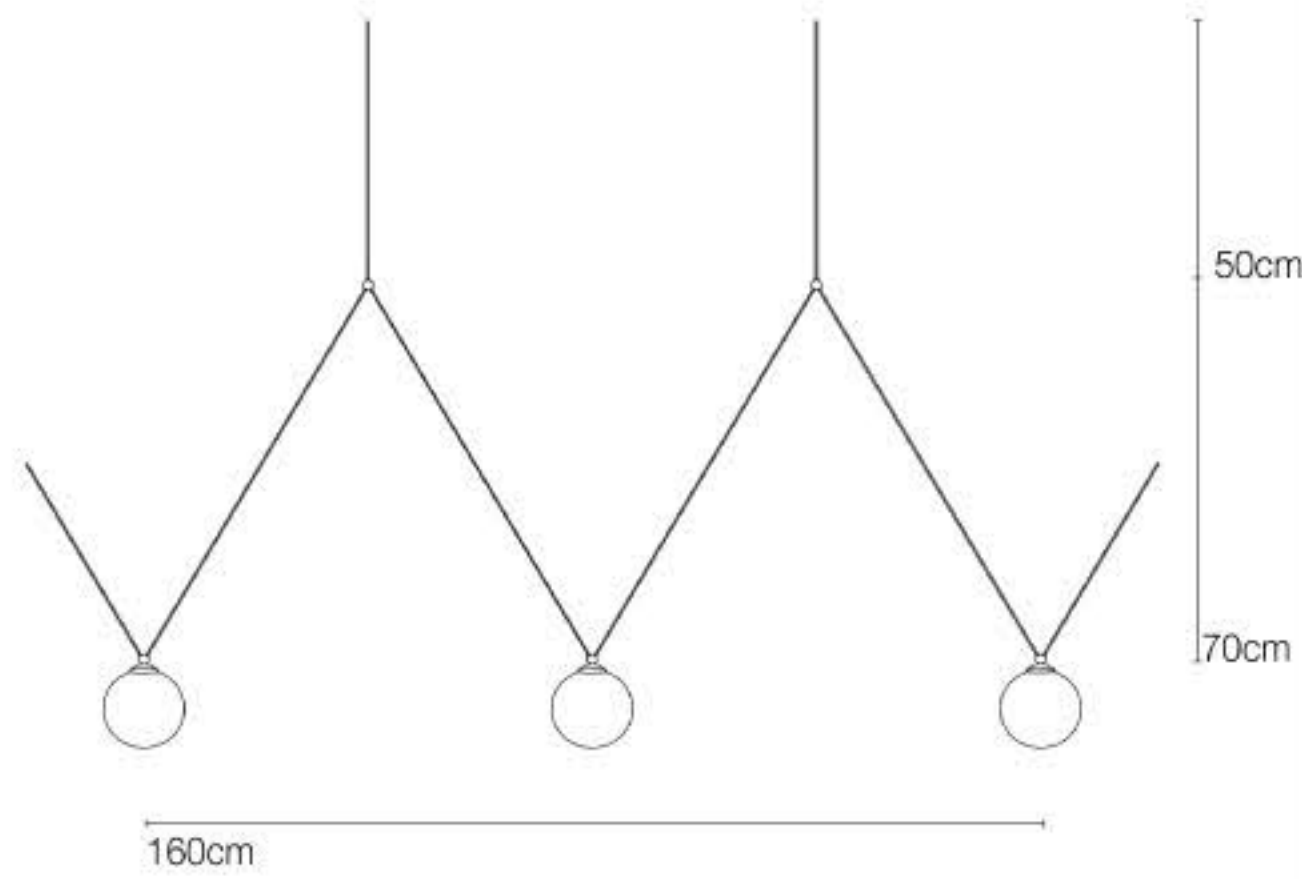

12 cm I
240 cm L
70 cm H



Brushed Brass



Mouthblow Opal
Mat Glass



ø 12 & 15 & 20 cm



LED E14



450-800 Lumens

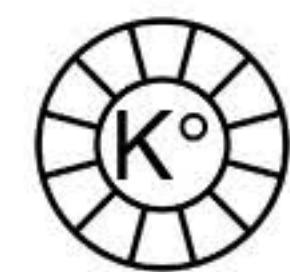

2700-6000 Kelvin



Dimmable



Norme CE





HE01

HERMES

According to the Greek mythology,
the young god Hermes and messenger of the gods.

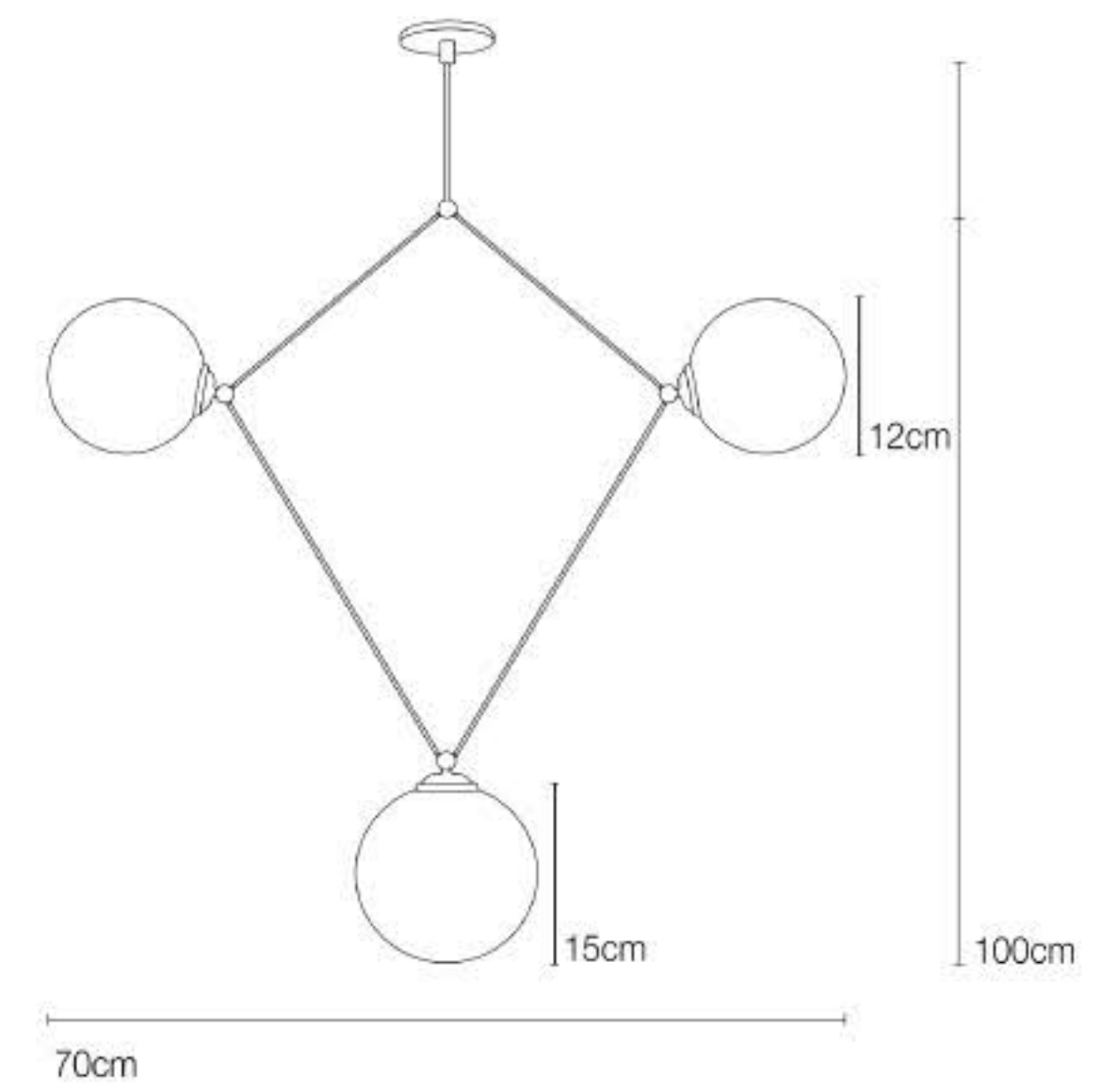

15 cm I
50 cm L
80 cm H



Brushed Brass



Mouthblow Opal
Mat Glass



ø 12 & 15 cm



LED E14



450-800 Lumens



2700-6000 Kelvin



Dimmable



Norme CE





12 cm I
180 cm L
100 cm H



Brushed Brass



Mouthblow Opal
Mat Glass



ø 12 & 15 cm



LED E14



450-800 Lumens



2700-6000 Kelvin



Dimmable



Norme CE

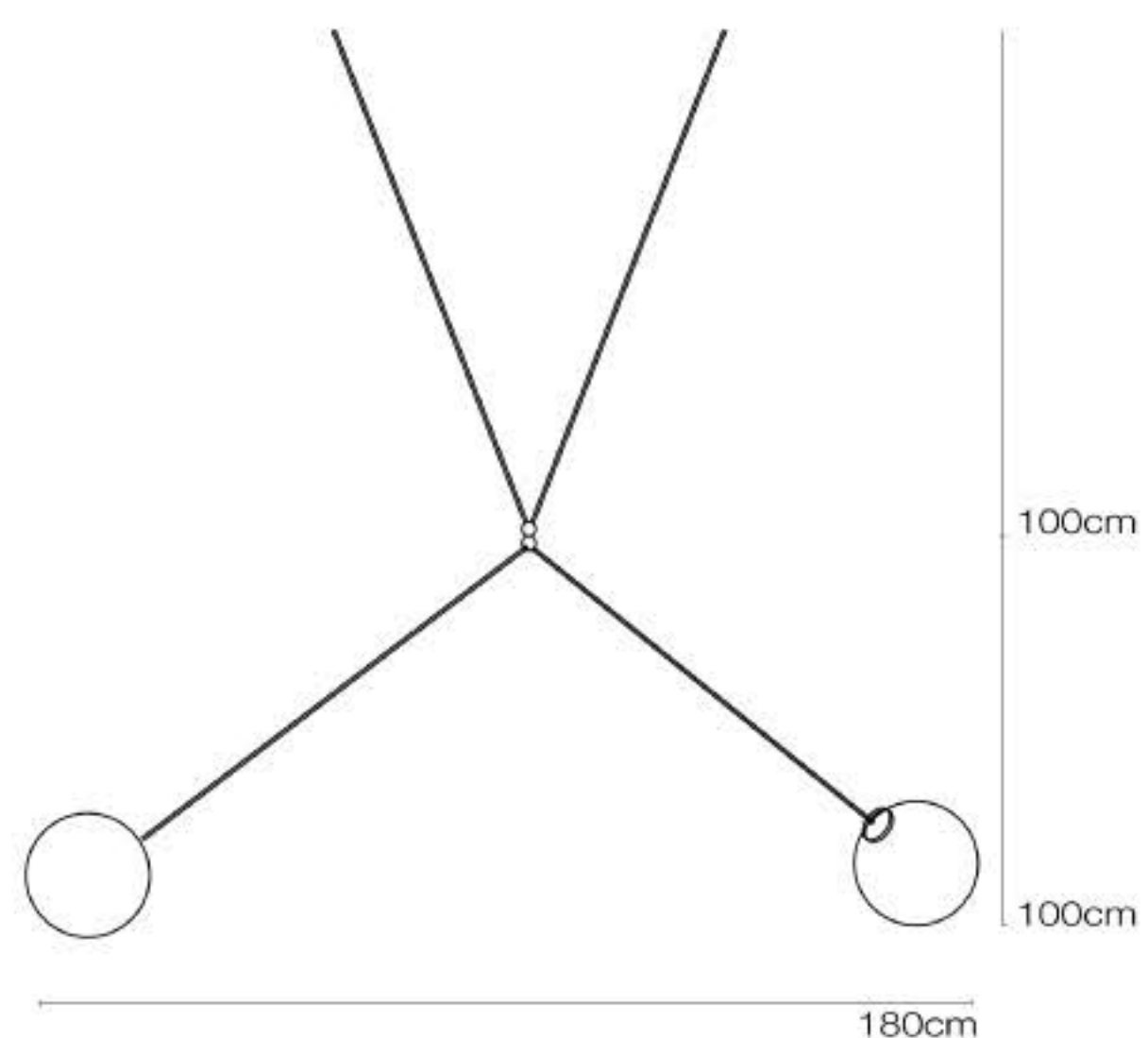

AT01

ATHOS

Athos threw an enormous rock on Poseidon from Thrace but the rock failed him and fell into the sea.



DI01

DIONYSOS

Venus is a Roman goddess who comes from a wave of the sea. She also is the goddess of beauty.

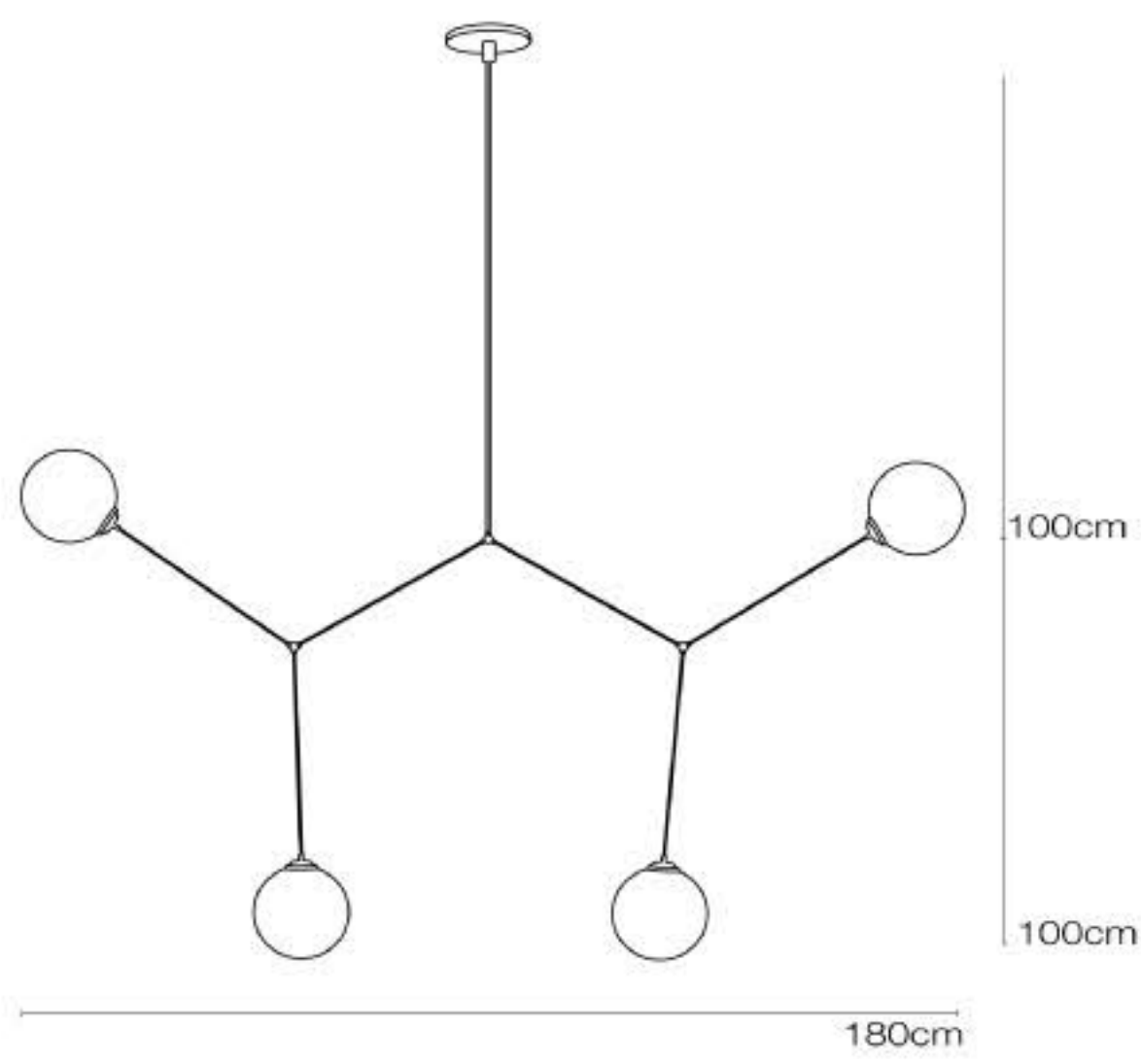

12 cm I
180 cm L
180 cm H



Brushed Brass



Mouthblow Opal
Mat Glass



ø 12 & 15



LED E14



450-800 Lumens



2700-6000 Kelvin



Dimmable



Norme CE







12 cm I
75 cm L
75 cm H



Brushed Brass



LED E14



450-800 Lumens



2700-6000 Kelvin



Dimmable



Norme CE

ZE01

ZEUS

His anger tears apart the sky.

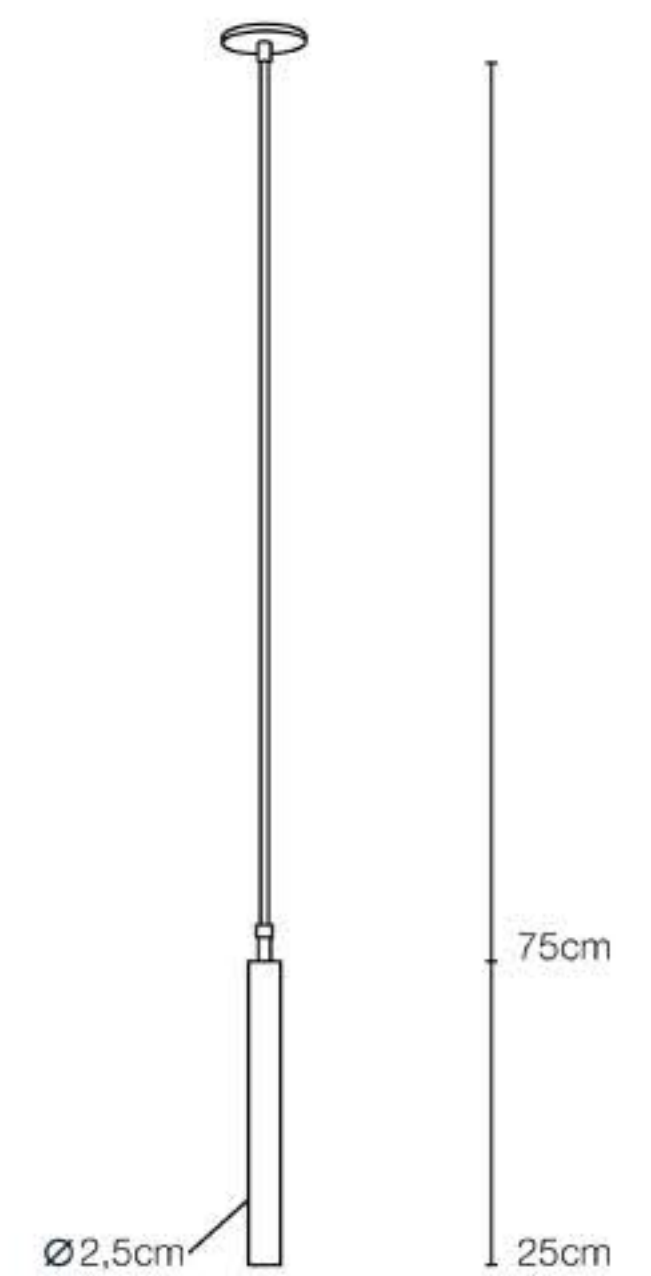



HE01

HÉLIOS

God of the Sun, crown of light.

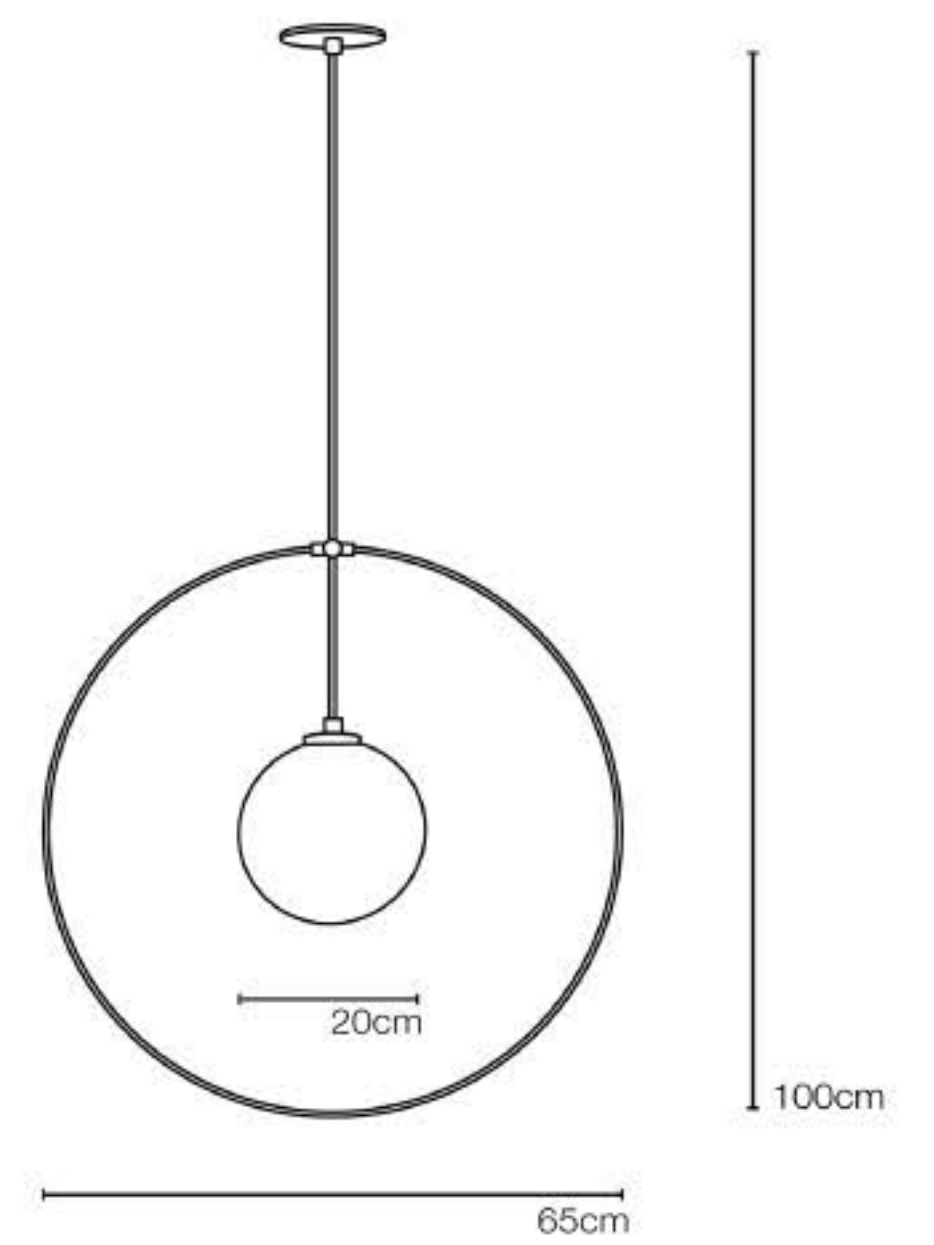

20cm I
65cm L
100cm H



Brushed Brass



Mouthblow Opal
Mat Glass



ø 12 & 15 & 20 cm



LED E14



450-800 Lumens



2700-6000 Kelvin



Dimmable



Norme CE





12 cm I
180 cm L
100 cm H



Brushed Brass



Mouthblow Opal
Mat Glass



ø 12 & 15 cm



LED E14



450-800 Lumens

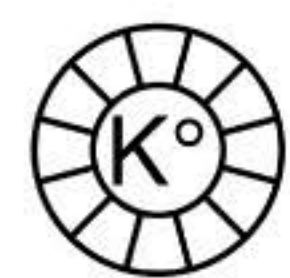

2700-6000 Kelvin



Dimmable



Norme CE

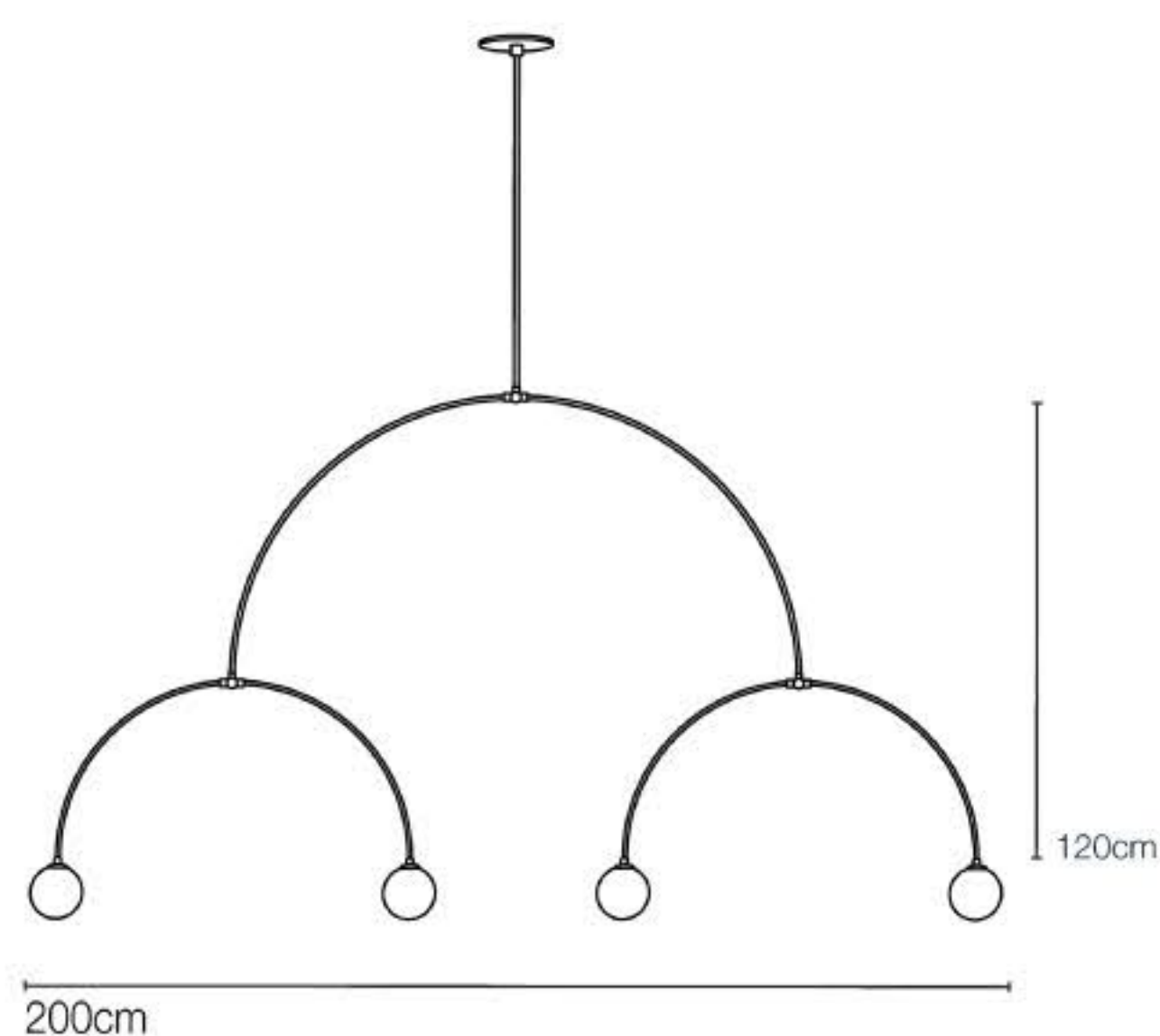

OL01

OLYMPIAS

A mythical, magical, magnificent Mount.



PO01

POSÉIDON

God of the Seas, his trident lights the oceans.

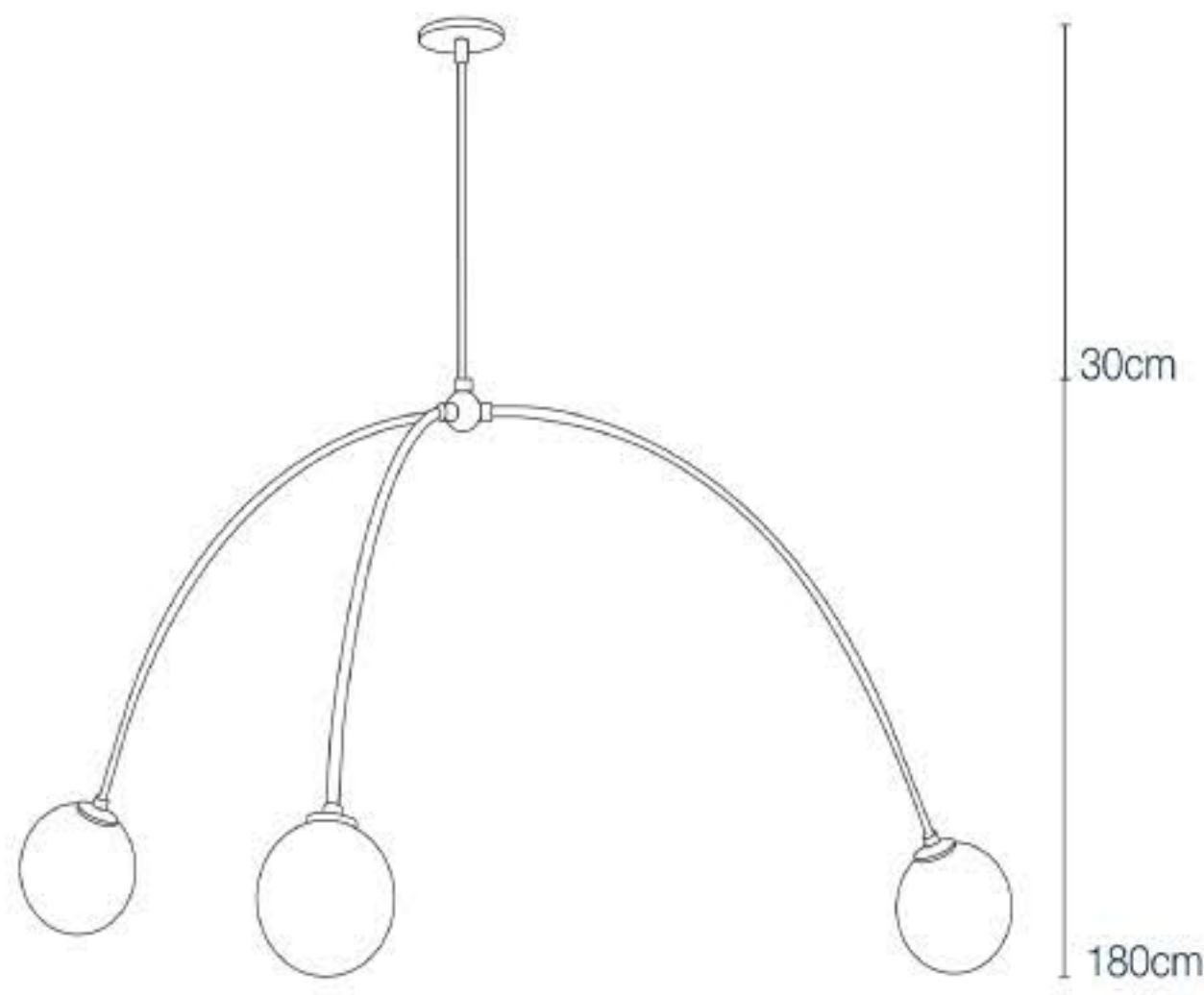

80 cm I
80 cm L
70 cm H



Brushed Brass



Mouthblow Opal
Mat Glass



ø 12 & 15



LED E14



450-800 Lumens

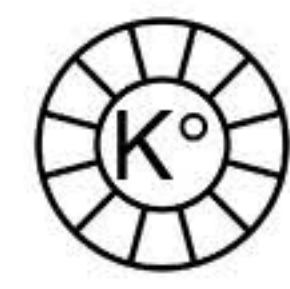

2700-6000 Kelvin



Dimmable



Norme CE





12 cm I
250 cm L
200 cm H



Brushed Brass



Mouthblow Opal
Mat Glass



ø 12 & 15 cm



LED E14



450-800 Lumens

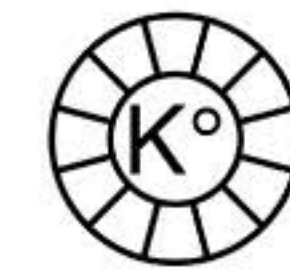

2700-6000 Kelvin



Dimmable



Norme CE

IR01

IRIS I

The rainbow that links the Earth and the Sun.

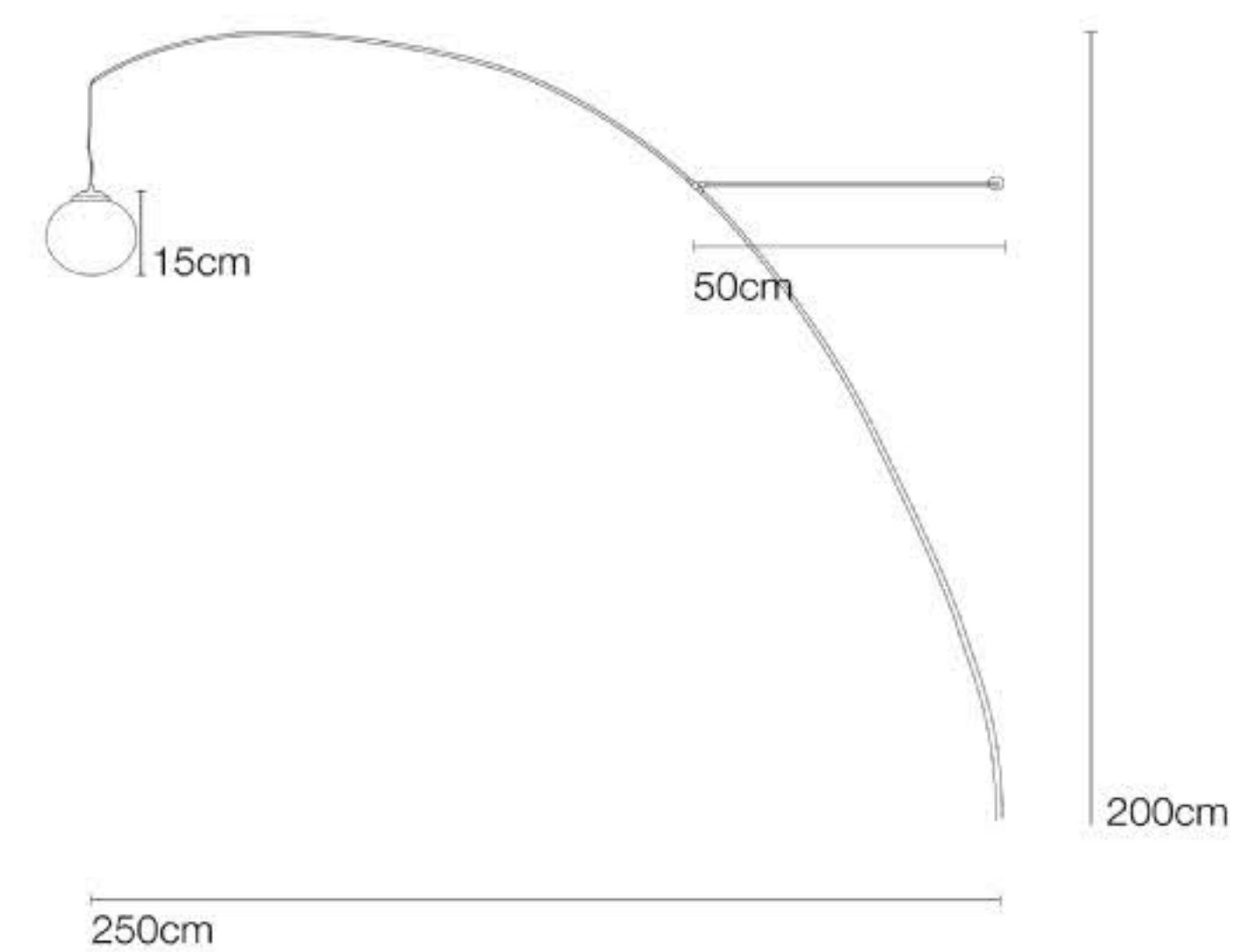



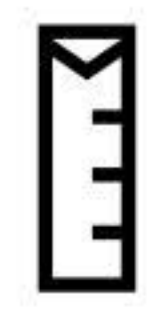

12 cm I
250 cm L
200 cm H



Brushed Brass



Mouthblow Opal
Mat Glass



ø 12 & 15 cm



LED E14



450-800 Lumens

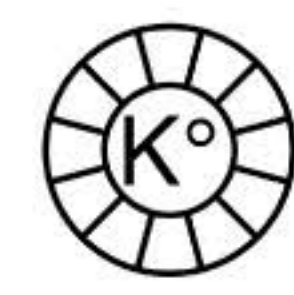

2700-6000 Kelvin

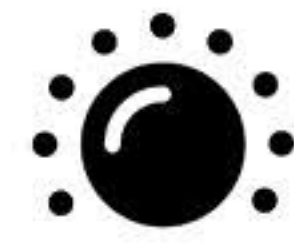

Dimmable



Norme CE

IR02

IRIS II

The rainbow that links the Earth and the Sun.

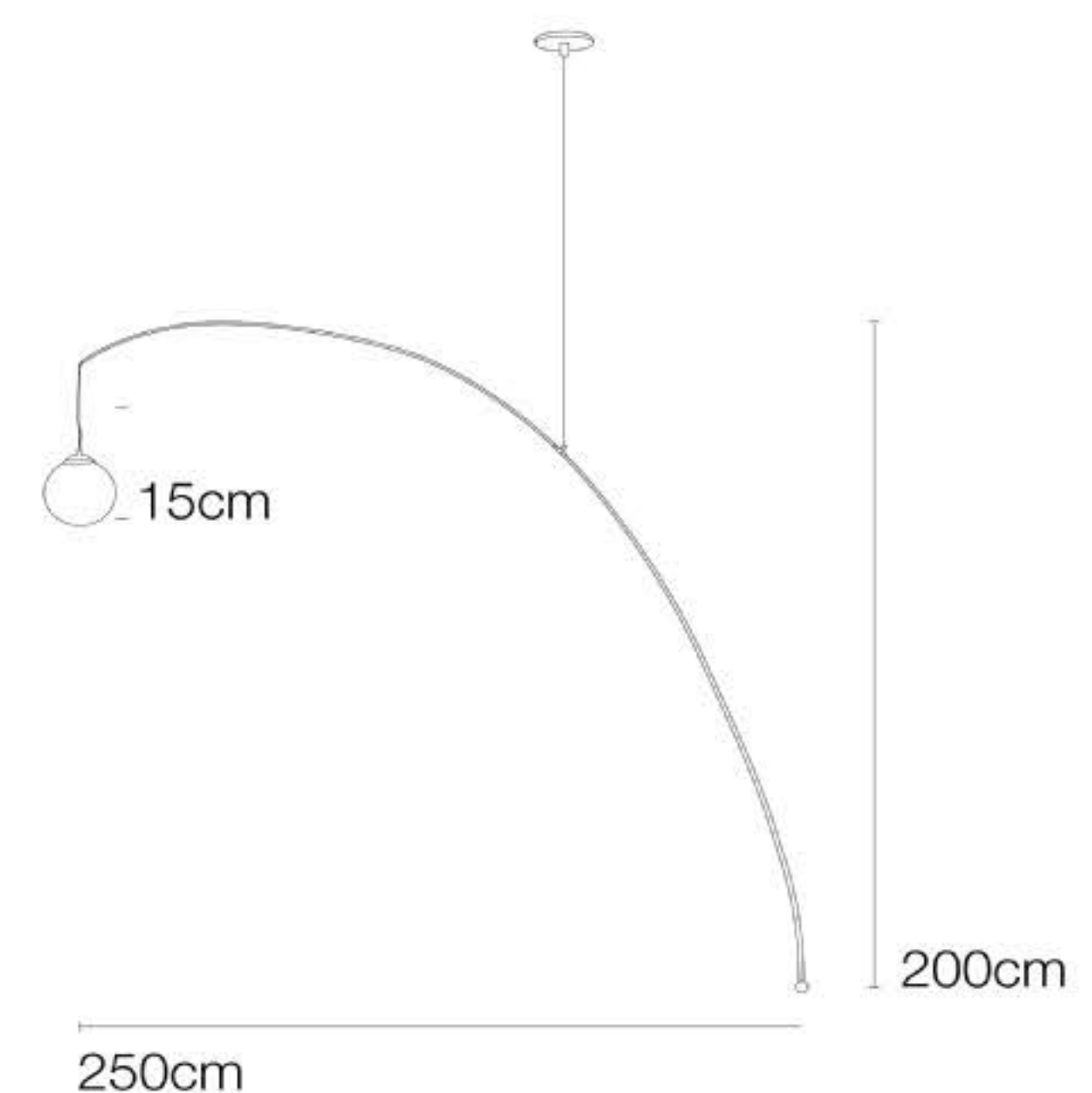



AR01

ARTÉMIS

The lamp fits the Goddess bow shape.

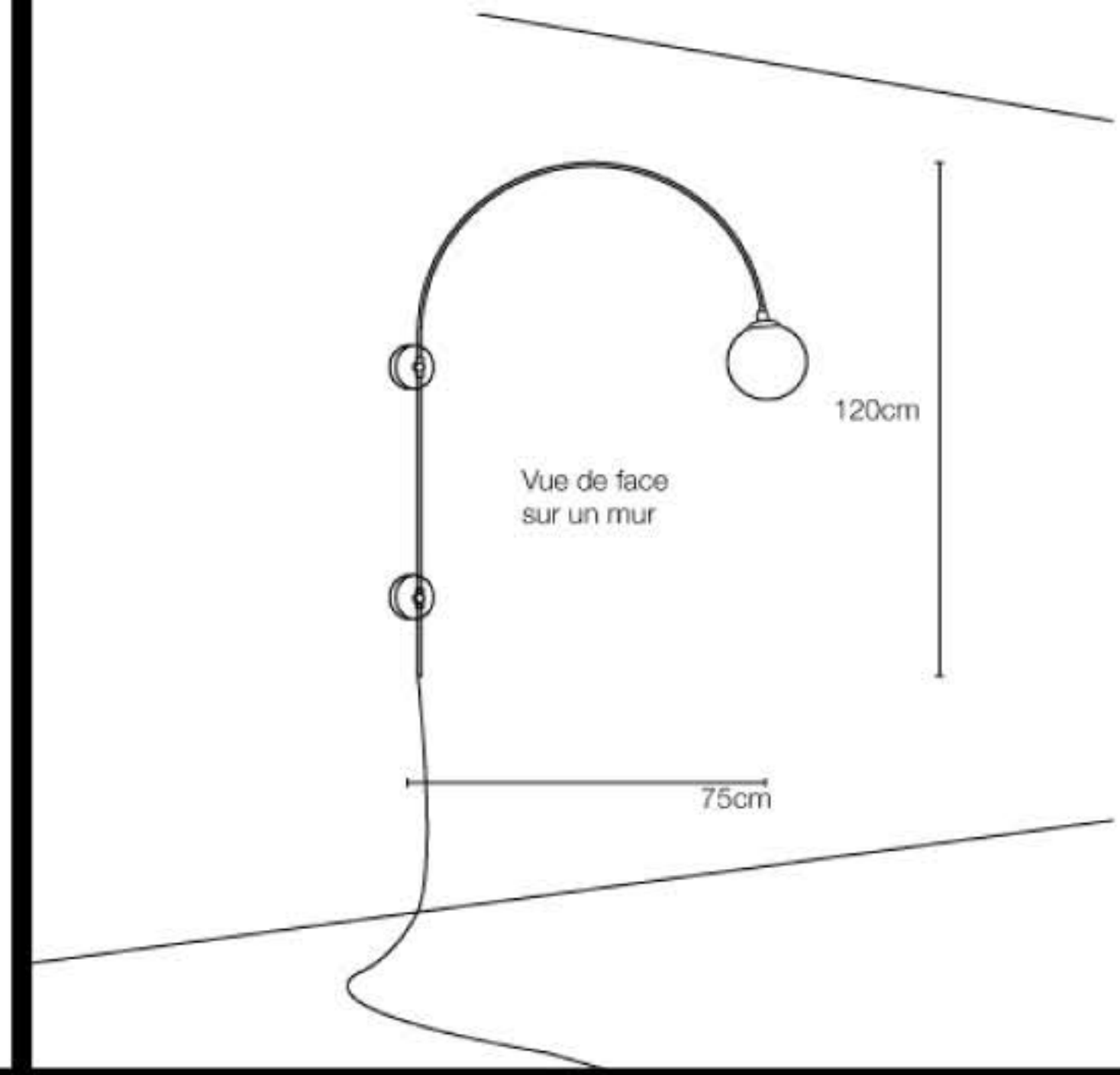

12cm l
65cm L
100cm H



Brushed Brass



Mouthblow Opal
Mat Glass



ø 12 & 15 & 20 cm



LED E14



450-800 Lumens



2700-6000 Kelvin



Dimmable



Norme CE





12 cm I
22 cm L
12 cm H



Brushed Brass



Mouthblow Opal
Mat Glass



ø 12 & 15 cm



LED E14



450-800 Lumens

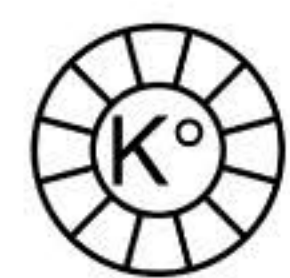

2700-6000 Kelvin



Dimmable



Norme CE

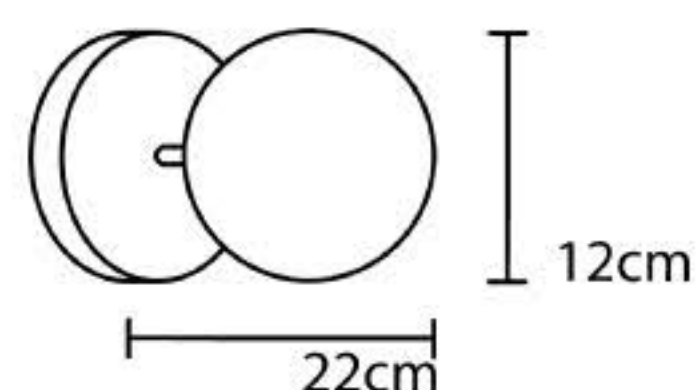

AN01

ANEMOI

Thanks to an adjustable inclination bracket system, the inclination of Anemmoi can be adjusted.



JA01

JANUS

This light is inspired by the Greek God Janus who had two heads, one looking towards the past and the other one towards the future.

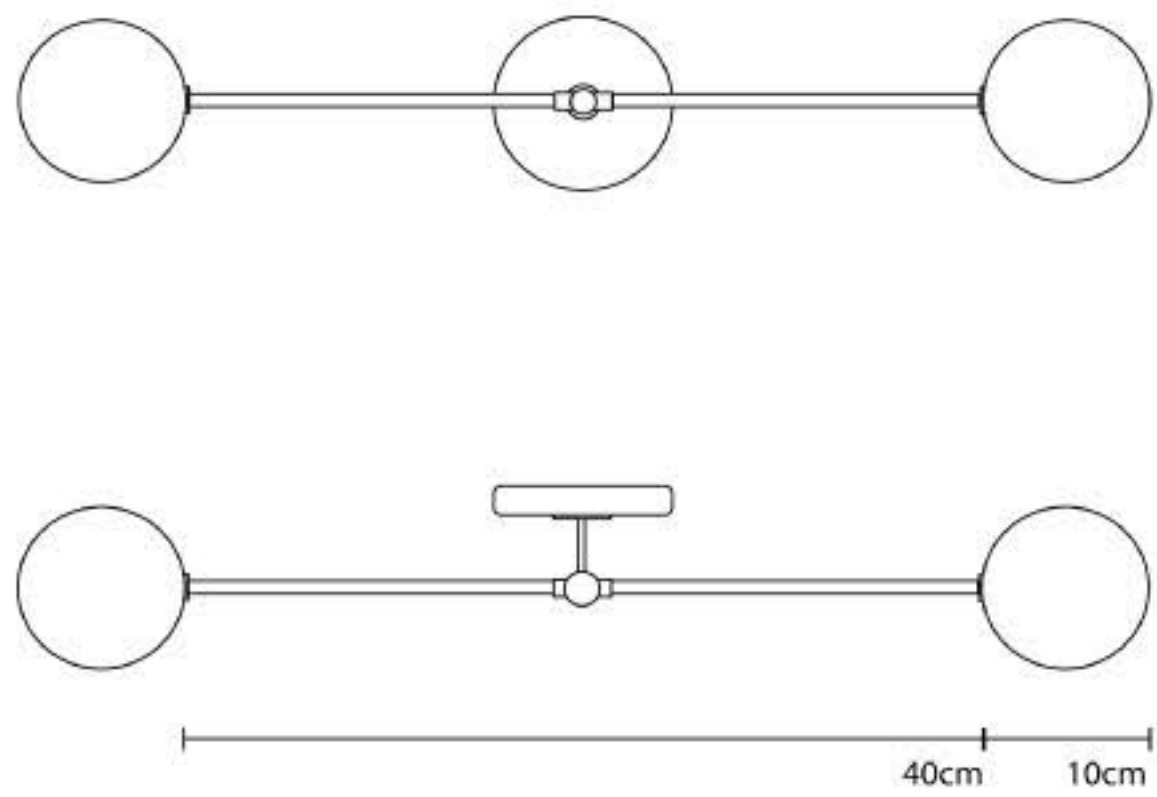

12 cm I
50 cm L
12 cm H



Brushed Brass



Mouthblow Opal
Mat Glass



ø 12 & 15



LED E14



450-800 Lumens

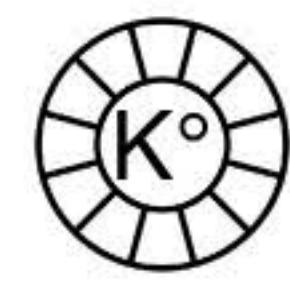

2700-6000 Kelvin



Dimmable



Norme CE







50 cm I
50 cm L
12 cm H



Brushed Brass



Mouthblow Opal
Mat Glass



ø 12 & 15 cm



LED E14



450-800 Lumens

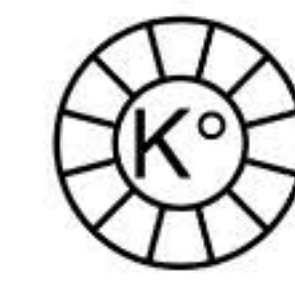

2700-6000 Kelvin



Dimmable



Norme CE

HE01

HECATE

Goddess with three light heads

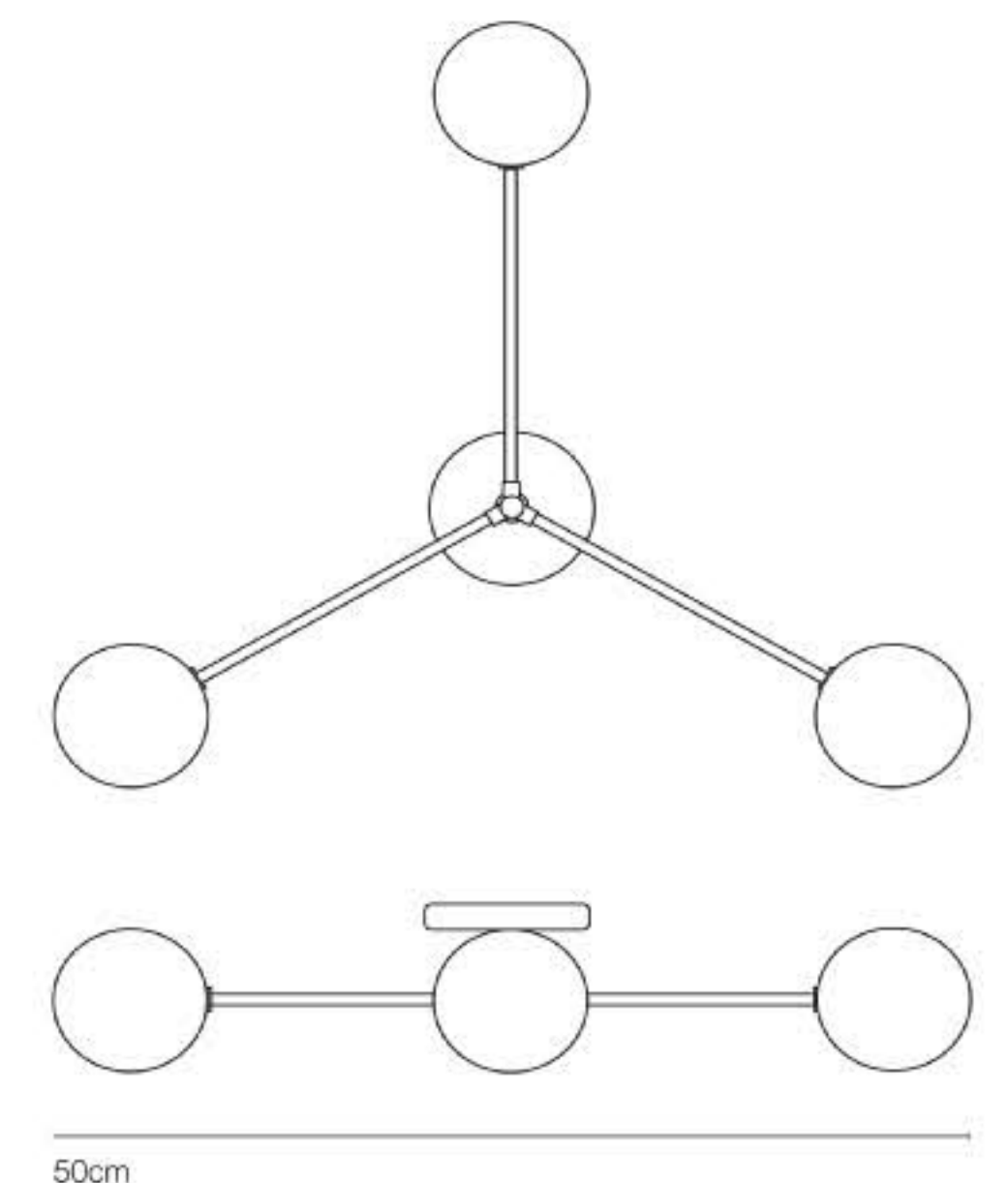



ZE01

ZÉPHYR

The lamp fits the Goddess bow shape.

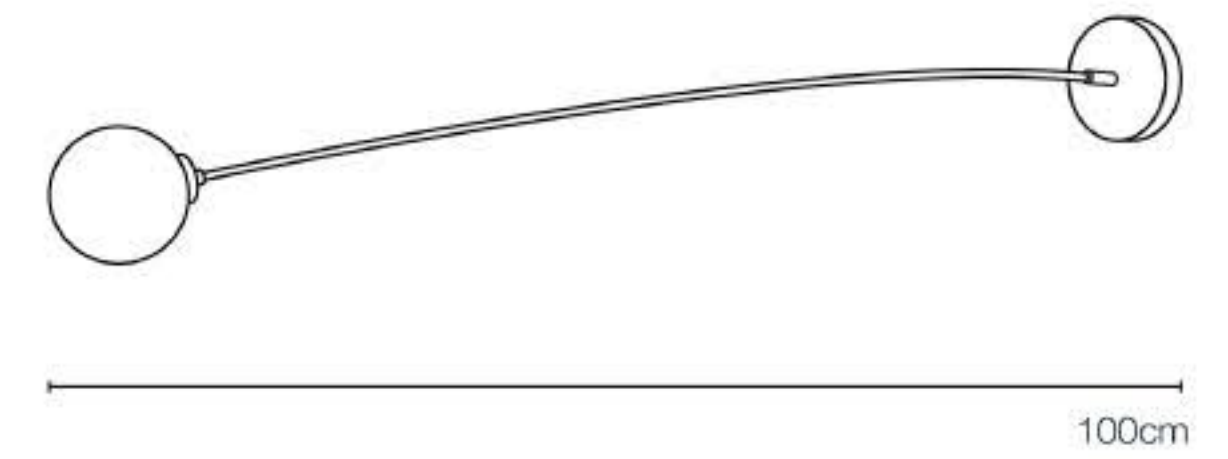

12cm I
100cm L
12cm H



Brushed Brass



Mouthblow Opal
Mat Glass



ø 12 & 15 & 20 cm



LED E14



450-800 Lumens



2700-6000 Kelvin



Dimmable



Norme CE

CAPSULES **COLLECTION**



Our collaborative creation or limited-edition



GOLDEN RATIO



A collection of 20 geometrically shaped lights inspired by the golden ratio, they dress and enliven the space with their play of light and shadow.





GOLDEN RATIO

Tamawa X Gobbo Lights



Tamawa, is a brand of contemporary design objects created in 2008 by designer Hubert Verstraeten.

This brand has a clear identity, the bakelite ball, used as the main material and component for all the products in his collection.

He is also the main subcontractor for our machined brass pieces.

<http://www.tamawa.be/>

Materials :

Blackened Brass

LED Tube S14D, 12w, 500lm, 2200k, dimmable

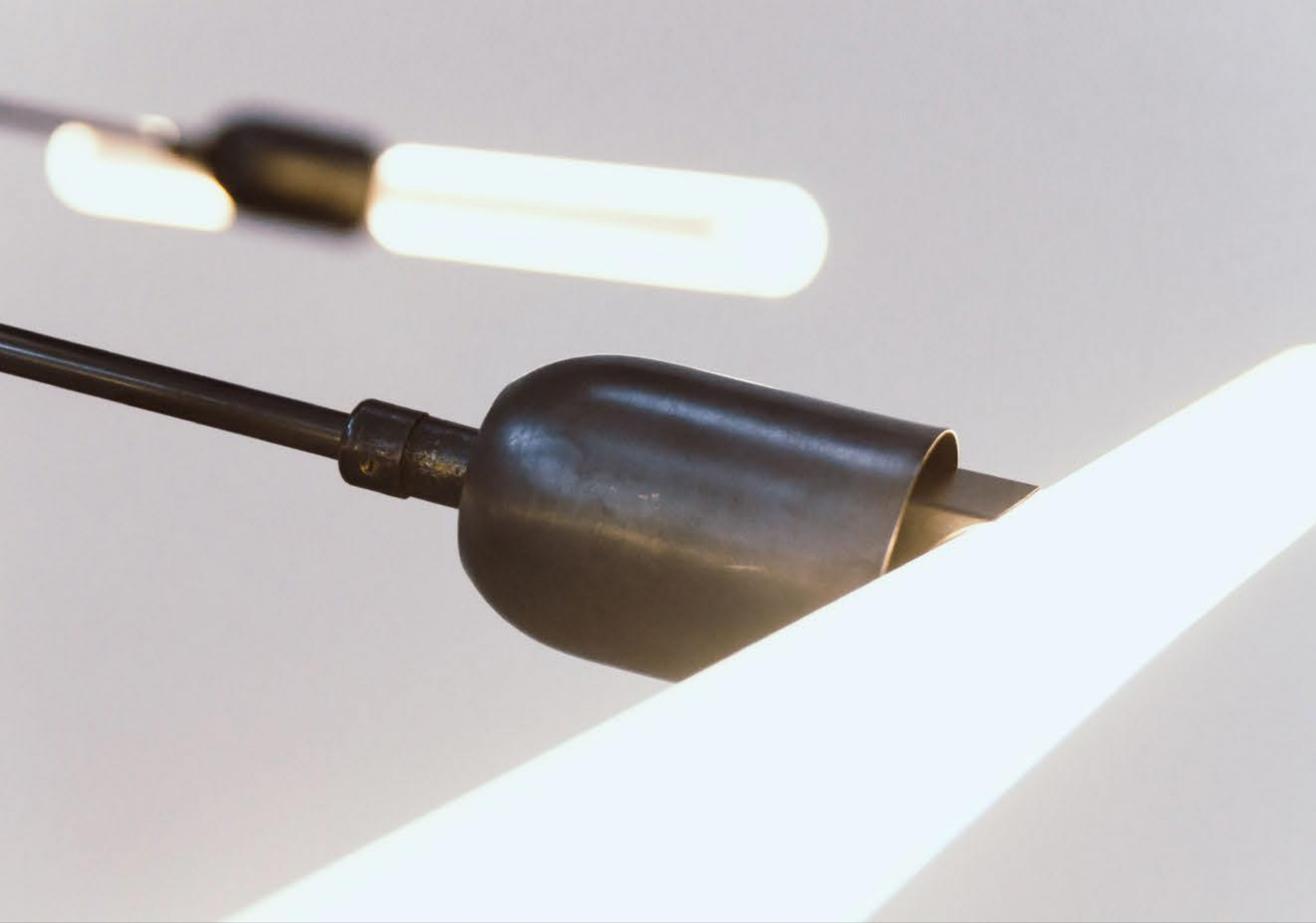

In this collaboration, the main connector is a bakelite ball made by the Tamawa studio.

This connector offers the possibility of connecting up to 7 branches.

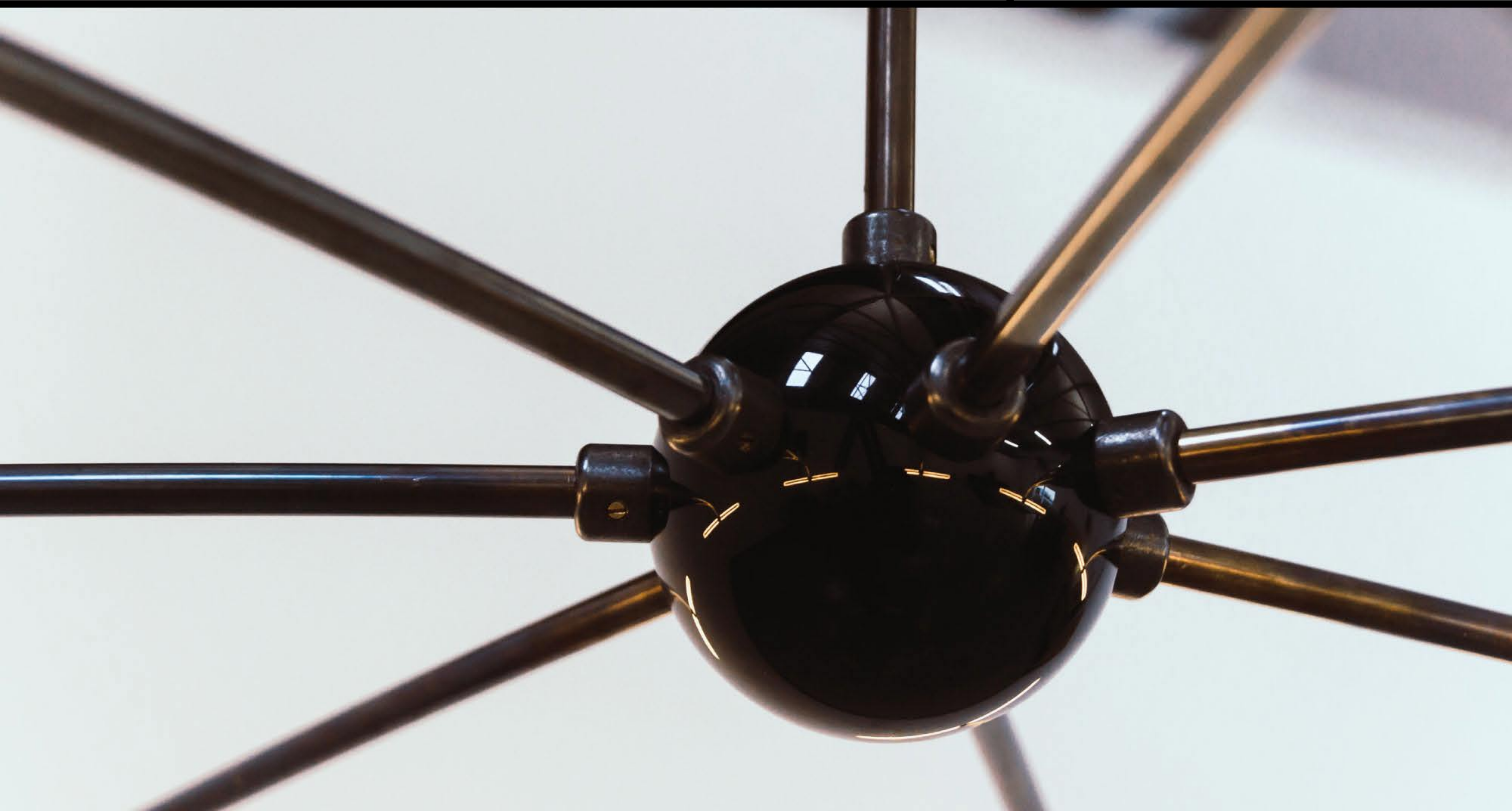

LES PIEDS DE BICHE X GOBO LIGHTS



Les PIEDS DE BICHE, a house created in Brussels by Diam Coly, offers a range of decorative objects with a modern and poetic spirit.

Geometric patterns, delicate colors and pure lines thrive on raw and authentic materials thus highlighting their qualities.
<http://www.lespiedsdebiche.be/>





From this collaboration was born a lamp in which the respective materials of the two designers are found.

Concrete for the tray and brass and glass for the light.

Material :

Tray : Black concrete & white granite

Light : Brass

Bulb : Mouthblow mat opaline (12 cm diam).

Led E14, 550 lm, 2700 Kelvin, dimmable.



NÉON FLEXIBLE

Our lights are now available with a flexible neon (360 °), you can sculpt the shape of this light yourself.

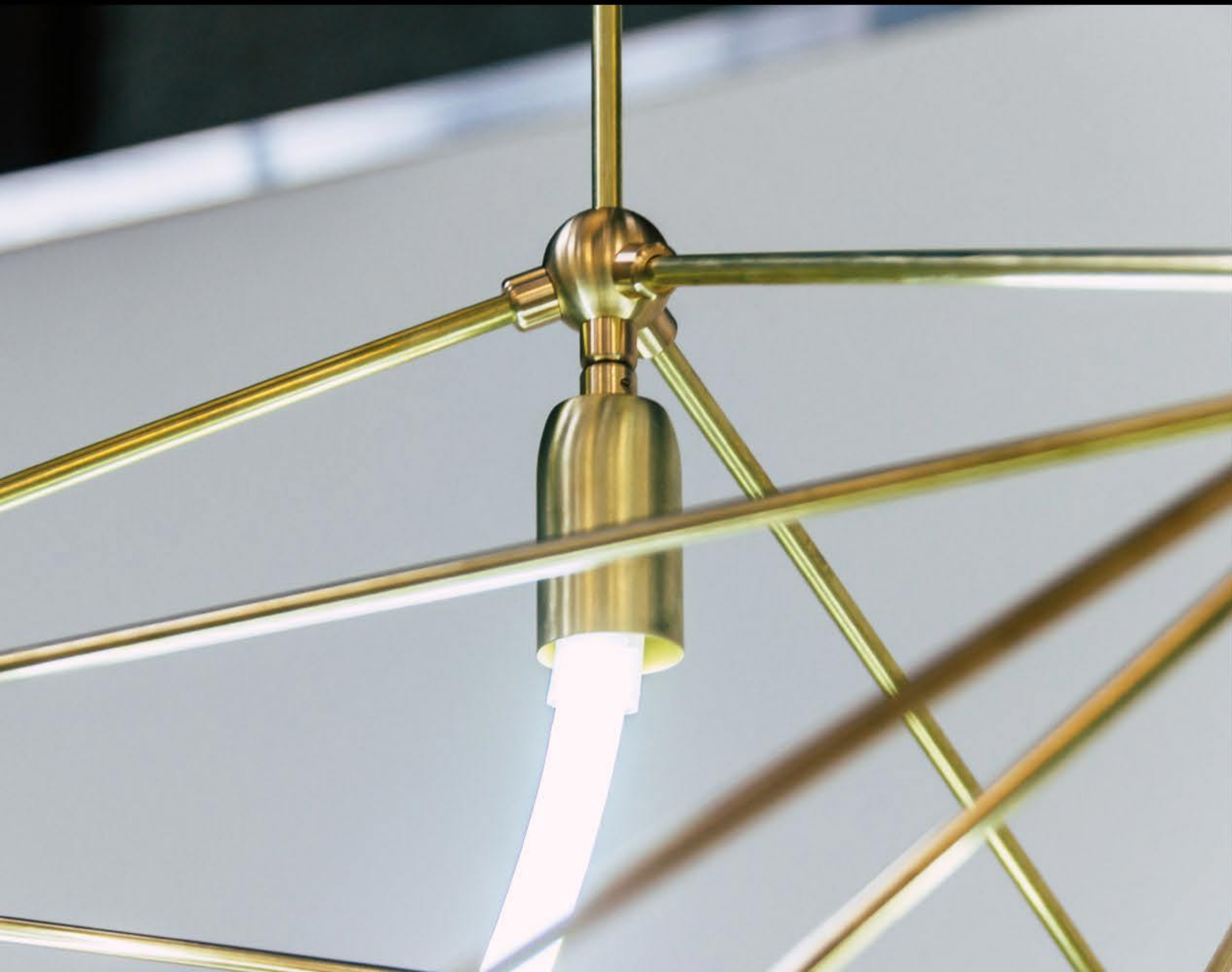

A veritable sculpture, this light represents the relationship between the golden ratio and geometry.

This proportion found in nature but also used in art, architecture and design.

LUMINAIRE **SCULPTURAL**

It's up to you to draw with the neon in the 3 golden rectangles that make up this light.

This sculptural light will bring a creative touch to your interior.

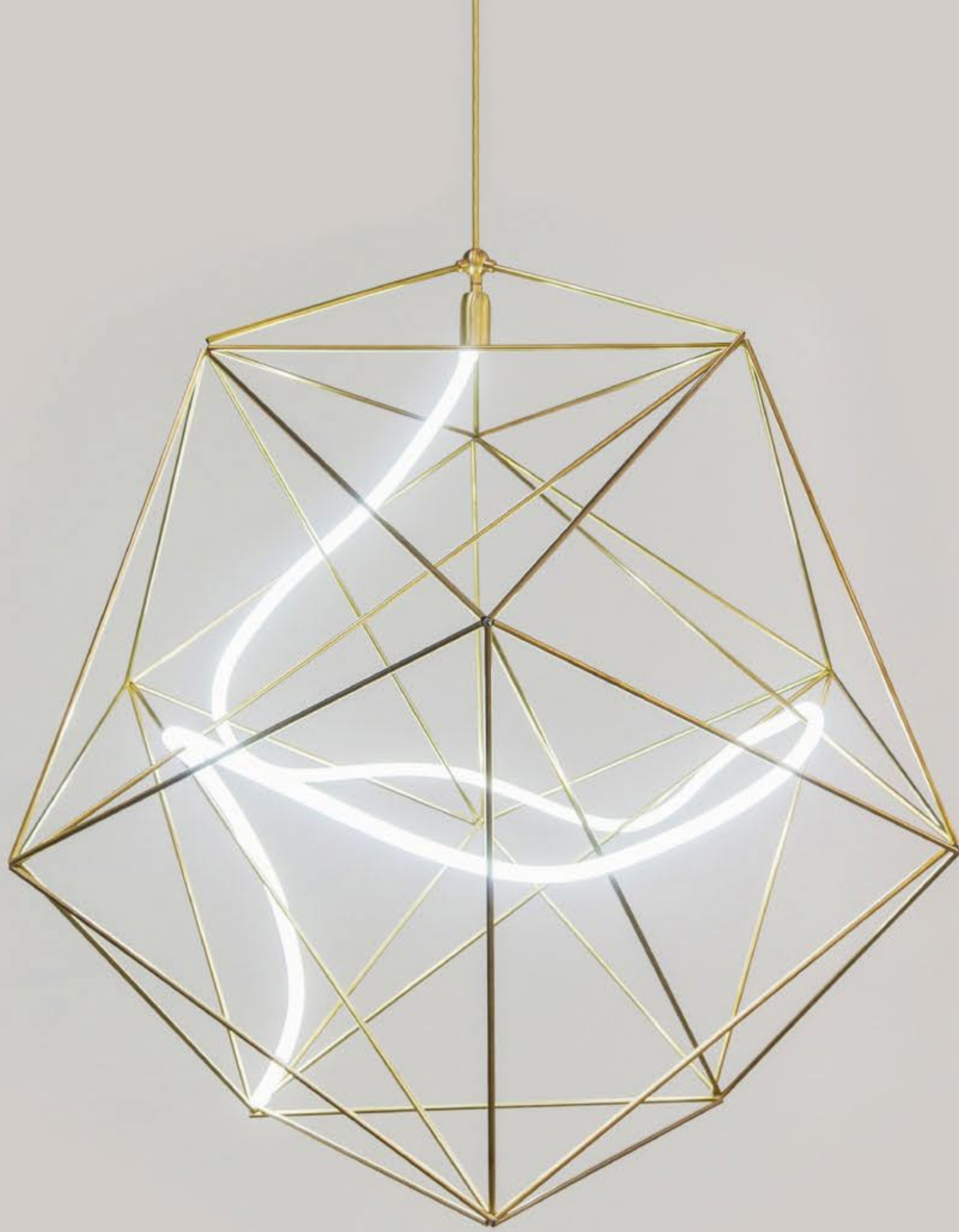

Contact



- Our studio / showroom is located in Brussels at La Vallée, a creative coworking space of a hundred projects on 6,000 m².

The studio is open by appointment during the working week from 10 a.m. to 6 p.m. It is also possible to arrange appointments during the weekend and in the evening.

Mail : info@gobolights.be

Phone : +32 499 19 33 21

Adress : La vallée, Rue Adolphe lavallée, 39, 1080 Molenbeek



Credits

Catalog layout : Thomas Bessat

Pictures & 3D : Thomas Bessat, Julie Calbert, Jodie Stella, Camille Cooken, Sebastien Thielens.

Translation : Noel Purcell O'byrne

Thanks :

Interns : Ophélie Vassal, Benjamin Van Santen, Mathias Sonet, Anais Neau, Armand Desmoulin, Alixe Boumeridja, Paulin Viguiier.

Thanks to : Chantal Purcell O'byrne, Libera Angelicchio, Karelle Lambert

Agent : Theartgency.

Powered by :

WBDM, HUB, MAD, JOBIN DESIGN, LA VALLEE, BELGIUM IS DESIGN, COMMUNAUTE FRANCAISE.



